

Visit

FREETESTPAPER.com

for more papers



Website: [freetestpaper.com](http://www.freetestpaper.com)



[Facebook.com/freetestpaper](https://www.facebook.com/freetestpaper)



[Twitter.com/freetestpaper](https://www.twitter.com/freetestpaper)



CEDAR GLEN SECONDARY SCHOOL
Preliminary Examination 2021
Secondary Four

CANDIDATE
NAME

CLASS

CLASS INDEX
NUMBER

CENTRE/
INDEX NO

 /

MATHEMATICS

Paper 1

4048/01

31 August 2021
2 hours

Candidates answer on the Question Paper.

READ THESE INSTRUCTIONS FIRST

Write your Centre number, index number and name on all the work you hand in.
Write in dark blue or black pen.
You may use a pencil for any diagrams or graphs.
Do not use staples, paper clips, highlighters, glue or correction fluid.

Answer **all** questions.

If working is needed for any question, it must be shown with the answer.

Omission of essential working will result in loss of marks.

You are expected to use a scientific calculator to evaluate explicit numerical expressions.

If the degree of accuracy is not specified in the question, and if the answer is not exact, give the answer to three significant figures. Give answers in degrees to one decimal place.

For π , use either your calculator value or 3.142, unless the question requires the answer in terms of π .

At the end of the examination, fasten all your work securely together.

The number of marks is given in brackets [] at the end of each question or part question.

The total number of marks for this paper is 80.

F. r Examiner's Use

80

This document consists of 19 printed pages and 1 blank page.

[Turn over]

Mathematical Formulae*Compound interest*

$$\text{Total amount} = P \left(1 + \frac{r}{100} \right)^n$$

Mensuration

$$\text{Curved surface area of a cone} = \pi r l$$

$$\text{Surface area of a sphere} = 4\pi r^2$$

$$\text{Volume of a cone} = \frac{1}{3} \pi r^2 h$$

$$\text{Volume of a sphere} = \frac{4}{3} \pi r^3$$

$$\text{Area of triangle } ABC = \frac{1}{2} ab \sin C$$

$$\text{Arc length} = r\theta, \text{ where } \theta \text{ is in radians}$$

$$\text{Sector area} = \frac{1}{2} r^2 \theta, \text{ where } \theta \text{ is in radians}$$

Trigonometry

$$\frac{a}{\sin A} = \frac{b}{\sin B} = \frac{c}{\sin C}$$

$$a^2 = b^2 + c^2 - 2bc \cos A$$

Statistics

$$\text{Mean} = \frac{\sum fx}{\sum f}$$

$$\text{Standard deviation} = \sqrt{\frac{\sum fx^2}{\sum f} - \left(\frac{\sum fx}{\sum f} \right)^2}$$

Answer all the questions.

1 Given that $\frac{4}{64^x} = 1$, find the value of x .

Answer _____ [1]

2 (a) Factorise completely $6x^2 + x - 2$.

Answer _____ [1]

(b) Hence, factorise completely $6(3m-1)^2 + 3m - 3$.

Answer _____ [2]

3 A range of values for x is represented on the number line below.

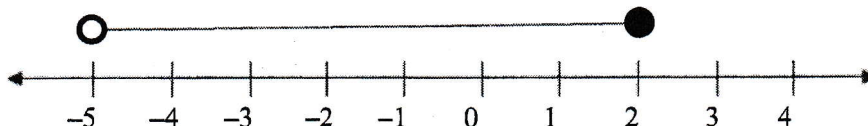

Given that x is an integer, find the smallest value of x^3 .

Answer _____ [1]

- 4 (a) Show that $y = 5 - x^2 - 4x$ has a maximum point $(-2, 9)$.

[3]

- (b) Sketch the graph of $y = 5 - x^2 - 4x$ on the axes below.
Indicate clearly the values where the graph crosses the axes
and the maximum point on the graph.

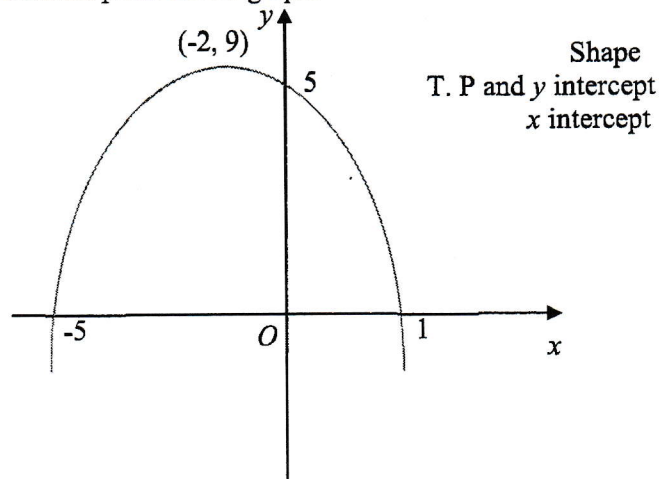

[3]

- (c) Hence, explain why the equation $x^2 + 4x + 5 = 0$ does not have any solutions. [2]

Answer _____

- 5 (a) Express 396 as the product of its prime factors.

Answer _____ [1]

- (b) Given that $16\,200 = 2^3 \times 3^4 \times 5^2$, find

- (i) the smallest possible integer value of k such that $396k$ is a multiple of 16 200,

Answer _____ [1]

- (ii) the smallest possible integer value of p such that $\frac{16\,200}{p}$ is a cube number.

Answer _____ [1]

- 6 The matrix T shows the number of training sessions Alyssa and Farah attended for the different training programmes in a year.

$$T = \begin{matrix} & \begin{matrix} \text{Circuit} & \text{Interval} & \text{Long Run} \end{matrix} \\ \begin{pmatrix} 50 & 100 & 150 \\ 60 & 100 & 160 \end{pmatrix} & \begin{matrix} \text{Alyssa} \\ \text{Farah} \end{matrix} \end{matrix}$$

- (a) The duration of each circuit session, interval session and long run is 40 minutes, 15 minutes and 120 minutes respectively. Represent the duration of the training programmes by a 3×1 column matrix S .

Answer [1]

- (b) Evaluate the matrix $R = TS$.

Answer [1]

- (c) State what the elements of R represent.

Answer _____
 _____ [1]

- (d) Evaluate the matrix $P = (-1 \ 1)R$.

Answer [1]

- (e) State what the element/s of P represent.

Answer _____
 _____ [1]

-
- 7 The diagram shows two regular pentagons $ABCDE$ and $DEFGH$.

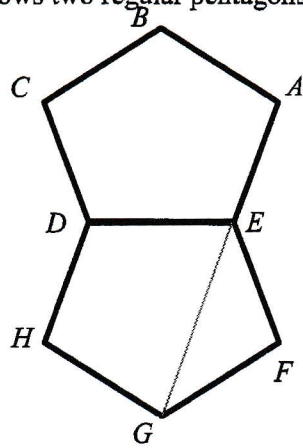

Show that the points A , E and G are collinear. Justify your answer.

[4]

-
- 8 A group of students sat for an examination.
50% of the boys and 40% of the girls passed the examination.
Megan commented that 45% of the students passed the examination.
Explain why Megan may be wrong.

Answer _

_____ [1]

9 The first five terms of a sequence are given below.

$$\frac{3}{2} \quad \frac{7}{8} \quad \frac{11}{18} \quad \frac{15}{32} \quad \frac{19}{50}$$

(a) Write down the next two terms.

Answer _____ [1]

(b) The k th term is $\frac{47}{288}$. Find k .

Answer _____ [1]

(c) Find an expression, in terms of n , for the n th term.

Answer _____ [2]

- 10 (a) A new housing estate is represented by an area of 200 cm^2 on a Map *A* drawn to a scale of $1 : n$. Given that the actual area is 32 km^2 , find the value of n .

Answer _____ [2]

- (b) The scale of another map, Map *B* is $1 : 65\,000$.
The length of a road on Map *B* is 50 cm .
Find the length of the road on Map *A*.

Answer _____ cm [2]

- 11 In the diagram below, $ABCD$ is a rhombus and the diagonal AC intersect the y -axis at E .

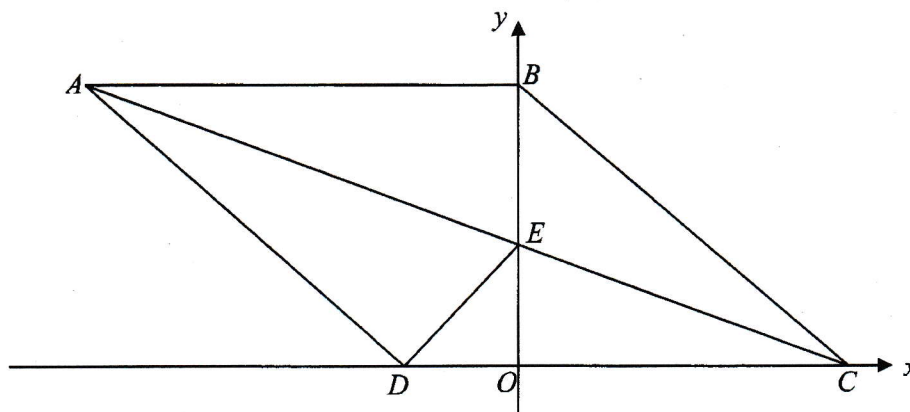

Show that the triangle AEB is congruent to triangle AED .

[3]

- 12 A box contains 80 paper clips, some of which are grey, some are yellow and the rest are blue.

The probability of drawing a grey clip is $\frac{1}{5}$ and the probability drawing a yellow clip is $\frac{1}{4}$.

- (a) Find the number of blue paper clips.

Answer _____ [1]

- (b) x blue paper clips are removed from the box so that the probability of drawing a blue clip from the box becomes $\frac{7}{25}$.

Find the value of x .

Answer _____ [2]

$$13 \quad p = \frac{1}{2} \sqrt{\frac{x^2 - 3y}{x^2}}$$

- (a) Evaluate p when $x = -12$ and $y = 4$, giving your answer correct to two decimal places.

Answer _____ [1]

- (b) Express x in terms of p and y .

Answer _____ [4]

14 ABC is a right-angled triangle with angle $ABC = 90^\circ$, $AB = 8$ cm and $BC = 15$ cm.

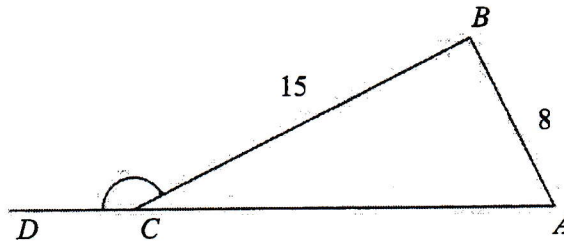

Find the value of $\cos \angle BCD$.

Answer _____ [2]

15 (a) Solve the inequalities $2x+13 < 4(x+2) \leq x+41$.

Answer _____ [3]

(b) Hence list all the prime integer values of x which satisfy the inequalities $2x+13 < 4(x+2) \leq x+41$.

Answer _____ [1]

- 16 In the diagram, A is the point $(-3, 1)$ and B is the point $(1, -4)$.
The line AC is parallel to the x -axis.

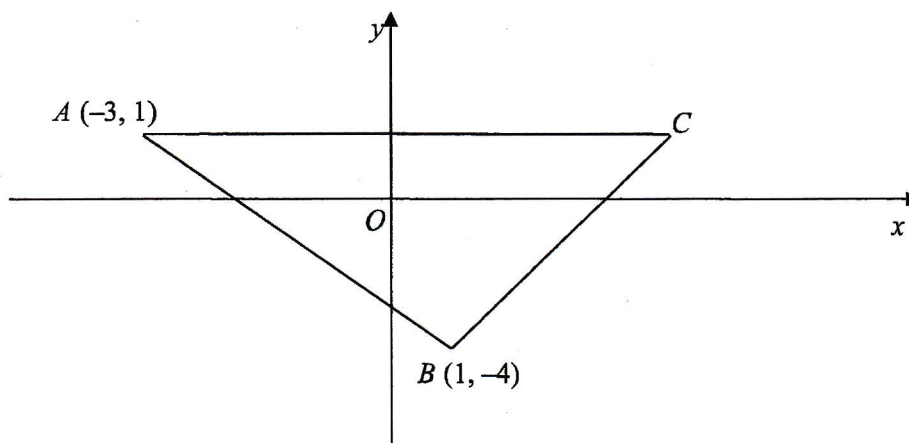

- (a) The equation of the line BC is $y - 2x = -6$. Find the coordinates of point C .

Answer _____ [1]

- (b) The line l is parallel to AB and passes through point C .
Find the equation of the line l .

Answer _____ [2]

- 17 In the diagram, BA and BC are tangents to the circle with centre O . BO meets the circle at D , $OA = 10$ cm and $BC = 28$ cm, find

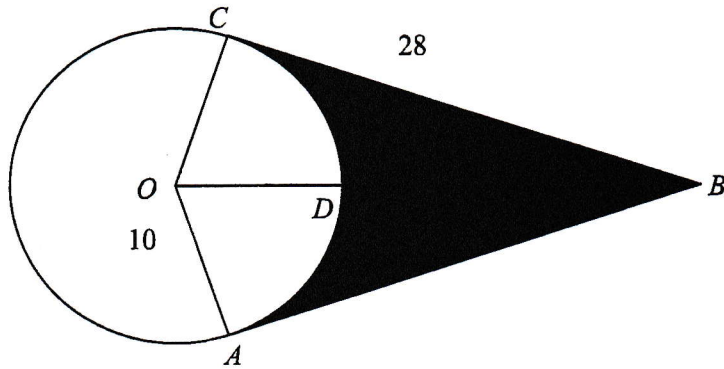

- (a) BD

Answer _____ cm [2]

- (b) The area of the shaded region $ABCD$.

Answer _____ cm^2 [4]

- 18 21 girls took a 40-metre shuttle run test.
The timings are shown in the stem-and-leaf diagram.

| Stem | Leaf |
|------|-------------|
| 10 | 3 4 5 5 |
| 10 | 6 7 7 8 9 |
| 11 | 0 2 2 2 4 5 |
| 11 | 6 8 9 |
| 12 | 2 3 |
| 12 | 5 |

Key: 10|3 means 10.3 seconds

- (a) Find the median time of the distribution.

Answer _____ s [1]

- (b) Find the interquartile range.

Answer _____ s [2]

- (c) The box-and-whisker plot shows the distribution of the timings obtained by the same group of girls in July 2021.

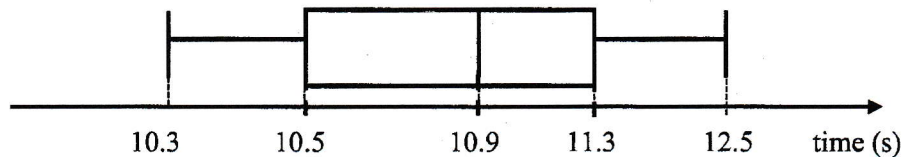

The teacher claims that the performance has improved and is more consistent in July 2021 than in January 2021.
Explain if this statement is true.

[2]

- 19 (a) The air resistance, R newtons, is directly proportional to the square of the speed, V m/s, of an object when it is falling.
The air resistance is 24 newtons at a certain speed.
Find the air resistance when the speed is increased by 50%.

Answer _____ newtons [3]

- (b) 16 workers can tile 2 rooms in 60 hours.
How many workers are needed if 5 rooms are to be tiled in 72 hours?

Answer _____ workers [2]

- 20 (a) In the space below, construct a quadrilateral such that $PS = 7$ cm, angle $QRS = 110^\circ$ and angle PSR is an acute angle. QR and QP have already been drawn.

[2]

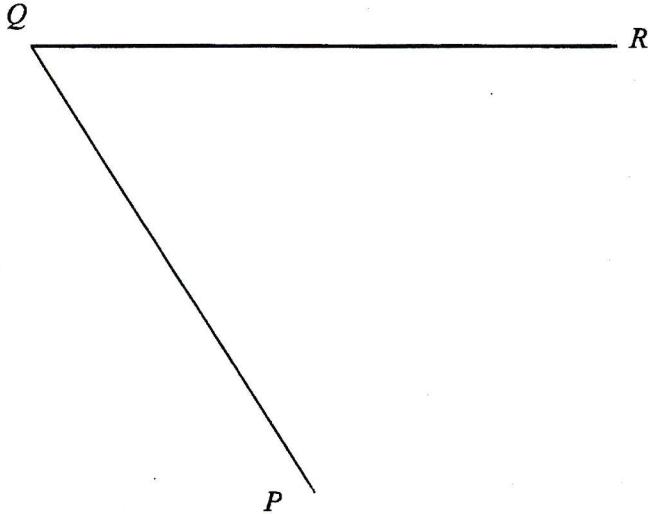

- (b) Construct the perpendicular bisector of PQ .
- (c) The perpendicular bisector in (b) intersects the line QR at T . Measure the angle QTP .

[1]

Answer _____ ° [1]

- 21 The diagram shows the speed-time graph for Sriya's 100 metre run during her school's sports day.

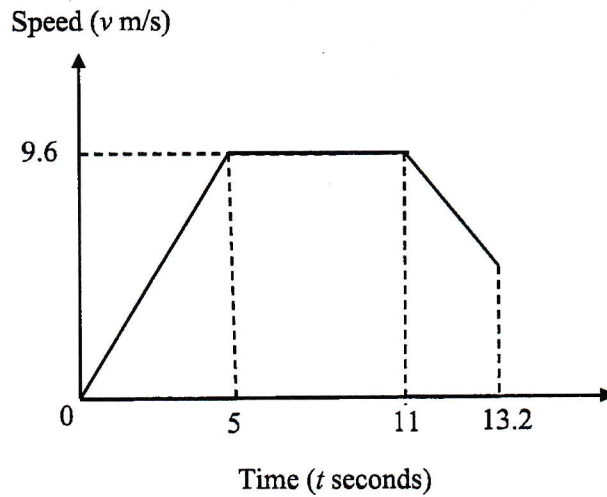

In the first 5 seconds, Sriya's accelerated uniformly to a speed of 9.6 m/s. She maintained her speed for the next 6 seconds and slowed down over the last 2.2 seconds. She crossed the finishing line after 13.2 seconds.

- (a) Calculate Sriya's acceleration 3 seconds after the race started.

Answer _____ m/s^2 [1]

- (b) Calculate the speed when she crossed the finishing line..

Answer _____ m/s [2]

- (c) The distance-time graph for another runner, Ella, in the same race is shown on the grid below.
Ella accelerated uniformly to a speed of 10.2 m/s and then maintained her speed until she crossed the finishing line.
She ran a distance of 29.7 m in the first 6 seconds.

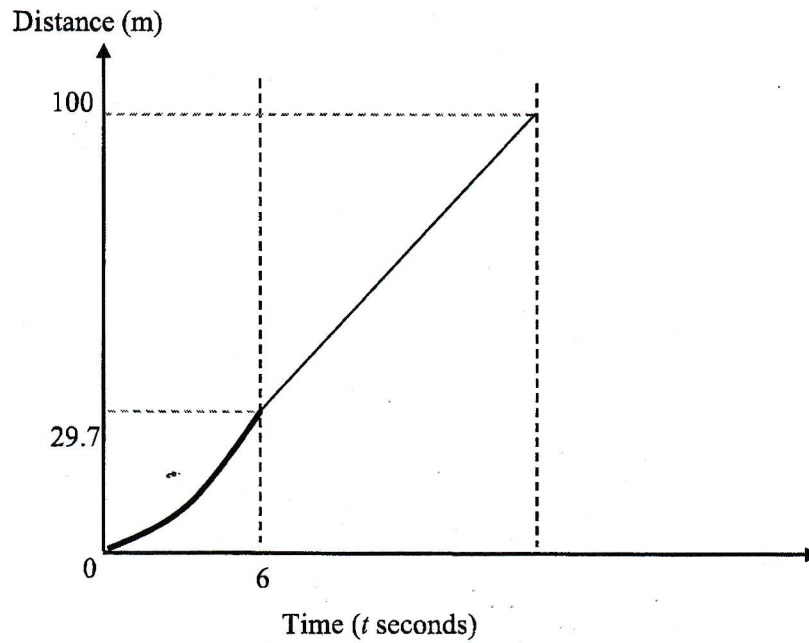

Who do you think won the race? Justify your answer.

[3]

End of Paper

BLANK PAGE

AN3



CEDAR GIRLS' SECONDARY SCHOOL
Preliminary Examination 2021
Secondary Four

CANDIDATE
NAME

Worked Solutions

CLASS

| | |
|--|--|
| | |
|--|--|

CLASS INDEX
NUMBER

| | |
|--|--|
| | |
|--|--|

CENTRE/
INDEX NO

| | | | | | | | | |
|--|--|--|--|---|--|--|--|--|
| | | | | / | | | | |
|--|--|--|--|---|--|--|--|--|

MATHEMATICS

Paper 1

4048/01

31 August 2021
2 hours

Candidates answer on the Question Paper.

READ THESE INSTRUCTIONS FIRST

Write your Centre number, index number and name on all the work you hand in.

Write in dark blue or black pen.

You may use a pencil for any diagrams or graphs.

Do not use staples, paper clips, highlighters, glue or correction fluid.

Answer **all** questions.

If working is needed for any question, it must be shown with the answer.

Omission of essential working will result in loss of marks.

You are expected to use a scientific calculator to evaluate explicit numerical expressions.

If the degree of accuracy is not specified in the question, and if the answer is not exact, give the answer to three significant figures. Give answers in degrees to one decimal place.

For π , use either your calculator value or 3.142, unless the question requires the answer in terms of π .

At the end of the examination, fasten all your work securely together.

The number of marks is given in brackets [] at the end of each question or part question.

The total number of marks for this paper is 80.

For Examiner's Use

80

Mathematical Formulae*Compound interest*

$$\text{Total amount} = P \left(1 + \frac{r}{100} \right)^n$$

Mensuration

$$\text{Curved surface area of a cone} = \pi r l$$

$$\text{Surface area of a sphere} = 4\pi r^2$$

$$\text{Volume of a cone} = \frac{1}{3} \pi r^2 h$$

$$\text{Volume of a sphere} = \frac{4}{3} \pi r^3$$

$$\text{Area of triangle } ABC = \frac{1}{2} ab \sin C$$

$$\text{Arc length} = r\theta, \text{ where } \theta \text{ is in radians}$$

$$\text{Sector area} = \frac{1}{2} r^2 \theta, \text{ where } \theta \text{ is in radians}$$

Trigonometry

$$\frac{a}{\sin A} = \frac{b}{\sin B} = \frac{c}{\sin C}$$

$$a^2 = b^2 + c^2 - 2bc \cos A$$

Statistics

$$\text{Mean} = \frac{\sum fx}{\sum f}$$

$$\text{Standard deviation} = \sqrt{\frac{\sum fx^2}{\sum f} - \left(\frac{\sum fx}{\sum f} \right)^2}$$

Answer all the questions.

- 1 Given that $\frac{4}{64^x} = 1$, find the value of x .

$$\begin{aligned} 4 &= 4^{3x} \\ 3x &= 1 \\ x &= \frac{1}{3} \end{aligned}$$

Answer $x = \frac{1}{3}$ [1]

- 2 (a) Factorise completely $6x^2 + x - 2$.

$$6x^2 + x - 2 = (2x - 1)(3x + 2)$$

Answer $(2x - 1)(3x + 2)$ [1]

- (b) Hence, factorise completely $6(3m - 1)^2 + 3m - 3$.

$$6(3m - 1)^2 + 3m - 3 = 6(3m - 1)^2 + (3m - 1) - 2$$

$$x = 3m - 1$$

$$\begin{aligned} 6(3m - 1)^2 + (3m - 1) - 2 &= (2(3m - 1) - 1)(3(3m - 1) + 2) \\ &= (6m - 3)(9m - 1) \\ &= 3(2m - 1)(9m - 1) \end{aligned}$$

Answer $3(2m - 1)(9m - 1)$ [2]

- 3 A range of values for x is represented on the number line below.

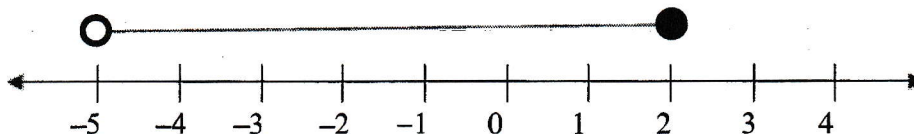

Given that x is an integer, find the smallest value of x^3 .

$$\text{Smallest value} = (-4)^3 = -64$$

Answer -64 [1]

- 4 (a) Show that $y = 5 - x^2 - 4x$ has a maximum point $(-2, 9)$.

Answer

$$\begin{aligned} y &= -(x^2 + 4x - 5) \\ &= -((x+2)^2 - 5 - (2)^2) \\ &= -((x+2)^2 - 9) \\ &= -(x+2)^2 + 9 \end{aligned}$$

Since coefficient of $x^2 < 0$

Therefore has a maximum turning point at $(-2, 9)$

[3]

- (b) Sketch the graph of $y = 5 - x^2 - 4x$ on the axes below.
Indicate clearly the values where the graph crosses the axes and the maximum point on the graph.

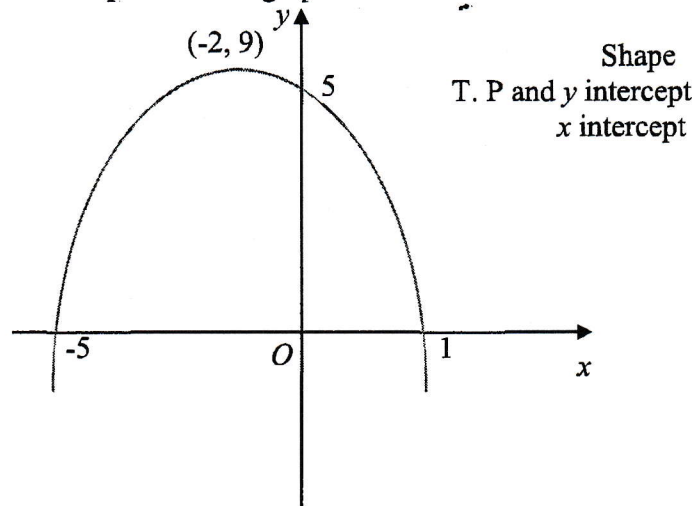

[3]

- (c) Hence, explain why the equation $x^2 + 4x + 5 = 0$ does not have any solutions. [2]

Answer $x^2 + 4x + 5 = 0$

$-x^2 - 4x - 5 = 0$

$-x^2 - 4x + 5 = 10$

By drawing a line $y = 10$, the line **does not meet** the curve,

Therefore the equation has no solutions.

- 5 (a) Express 396 as the product of its prime factors.

$$396 = 2^2 \times 3^2 \times 11$$

Answer $2^2 \times 3^2 \times 11$ [1]

- (b) Given that $16\,200 = 2^3 \times 3^4 \times 5^2$, find

- (i) the smallest possible integer value of k such that $396k$ is a multiple of 16 200,

$$396k = 2^2 \times 3^2 \times 11 \times k$$

$$16\,200 = 2^3 \times 3^4 \times 5^2$$

$$k = 2 \times 3^2 \times 5^2$$

$$= 450$$

Answer $k = 450$ [1]

- (ii) the smallest possible integer value of p such that $\frac{16\,200}{p}$ is a cube number.

$$\frac{16\,200}{p} = \frac{2^3 \times 3^4 \times 5^2}{3 \times 5^2}$$

$$p = 75$$

Answer $p = 75$ [1]

- 6 The matrix T shows the number of training sessions Alyssa and Farah attended for the different training programmes in a year.

$$T = \begin{matrix} & \begin{matrix} \text{Circuit} & \text{Interval} & \text{Long Run} \end{matrix} \\ \begin{pmatrix} 50 & 100 & 150 \\ 60 & 100 & 160 \end{pmatrix} & \begin{matrix} \text{Alyssa} \\ \text{Farah} \end{matrix} \end{matrix}$$

- (a) The duration of each circuit session, interval session and long run is 40 minutes, 15 minutes and 120 minutes respectively. Represent the duration of the training programmes by a 3×1 column matrix S .

$$\text{Answer } S = \begin{pmatrix} 40 \\ 15 \\ 120 \end{pmatrix} \quad [1]$$

- (b) Evaluate the matrix $R = TS$.

$$R = \begin{pmatrix} 50 & 100 & 150 \\ 60 & 100 & 160 \end{pmatrix} \begin{pmatrix} 40 \\ 15 \\ 120 \end{pmatrix} \\ = \begin{pmatrix} 21500 \\ 23100 \end{pmatrix}$$

$$\text{Answer } R = \begin{pmatrix} 21500 \\ 23100 \end{pmatrix} \quad [1]$$

- (c) State what the elements of R represent.

Answer The total duration in minutes on training by Alyssa (21 500 min)
and Farah (23100 mins) in a year [1]

- (d) Evaluate the matrix $P = (-1 \ 1)R$.

$$P = (-1 \ 1) \begin{pmatrix} 21500 \\ 23100 \end{pmatrix} \\ = (1600)$$

$$\text{Answer } P = (1600) \quad [1]$$

- (e) State what the element/s of P represent.

Answer The difference in the time spent on training between Alyssa and Farah in a year. [1]

- 7 The diagram shows two regular pentagons $ABCDE$ and $DEFGH$.

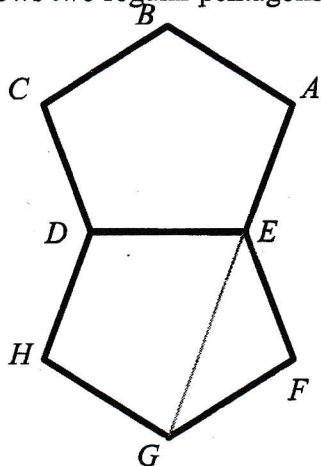

Show that the points A , E and G are collinear. Justify your answer.

$$\begin{aligned}\angle AED &= \frac{3 \times 180^\circ}{5} \\ &= 108^\circ = \angle EFG \\ \angle FEG &= \frac{180^\circ - 108^\circ}{2} \quad (\text{base angles of isosceles triangle}) \\ &= 36^\circ \\ \angle GED &= 108^\circ - 36^\circ \\ &= 72^\circ \\ \therefore \angle AEG &= \angle AED + \angle GED \\ &= 108^\circ + 72^\circ \\ &= 180^\circ\end{aligned}$$

Therefore the points A , E and G are collinear.

[4]

- 8 A group of students sat for an examination.
50% of the boys and 40% of the girls passed the examination.
Megan commented that 45% of the students passed the examination.
Explain why Megan may be wrong.

Answer The number of boys and girls in the school may not be equal. [1]

9 The first five terms of a sequence are given below.

$$\frac{3}{2} \quad \frac{7}{8} \quad \frac{11}{18} \quad \frac{15}{32} \quad \frac{19}{50}$$

(a) Write down the next two terms.

Answer $\frac{23}{72}, \frac{27}{98}$ [1]

(b) The k th term is $\frac{47}{288}$. Find k .

Answer $k = 12$ [1]

(c) Find an expression, in terms of n , for the n th term.

Numerator: $\underbrace{(-1)}_{4n-1} \quad \underbrace{(-4)}_3 \quad \underbrace{(+4)}_7 \quad \underbrace{(+4)}_{11}$

Denominator: $2 \quad 8 \quad 18 \quad 32 \quad 50$
 $\underbrace{\quad}_6 \quad \underbrace{\quad}_{10} \quad \underbrace{\quad}_{14} \quad \underbrace{\quad}_{18}$
 $\underbrace{\quad}_2 \quad \underbrace{\quad}_2 \quad \underbrace{\quad}_2$

Use mode 3, 2

$$1 \quad 1 \quad 1 \quad 2$$

$$4 \quad 2 \quad 1 \quad 8$$

$$9 \quad 3 \quad 1 \quad 18$$

Using

$$an^2 + bn + c$$

$$2n^2$$

Answer $\frac{4n-1}{2n^2}$ [2]

- 10 (a) A new housing estate is represented by an area of 200 cm^2 on a Map *A* drawn to a scale of $1 : n$. Given that the actual area is 32 km^2 , find the value of n .

| Map | Actual |
|--------------------|-----------------------|
| 200 cm^2 | 32 km^2 |
| 100 cm^2 | 16 km^2 |
| 10 cm | 4 km |
| | $400\,000 \text{ cm}$ |
| 1 | $40\,000$ |

Answer $n = \underline{40\,000}$ [2]

- (b) The scale of another map, Map *B* is $1 : 65\,000$.
The length of a road on Map *B* is 50 cm .
Find the length of the road on Map *A*.

| | | | |
|-------|-------|---|-----------|
| Map B | 1 cm | : | 65 000 cm |
| | 1 cm | | 0.65 km |
| | 50 cm | | 32.5 km |

| | | |
|-------|---------|----------|
| Map A | 4 km | 10 cm |
| | 32.5 km | 81.25 cm |

Answer $\underline{81.25}$ cm [2]

- 11 In the diagram below, $ABCD$ is a rhombus and the diagonal AC intersect the y -axis at E .

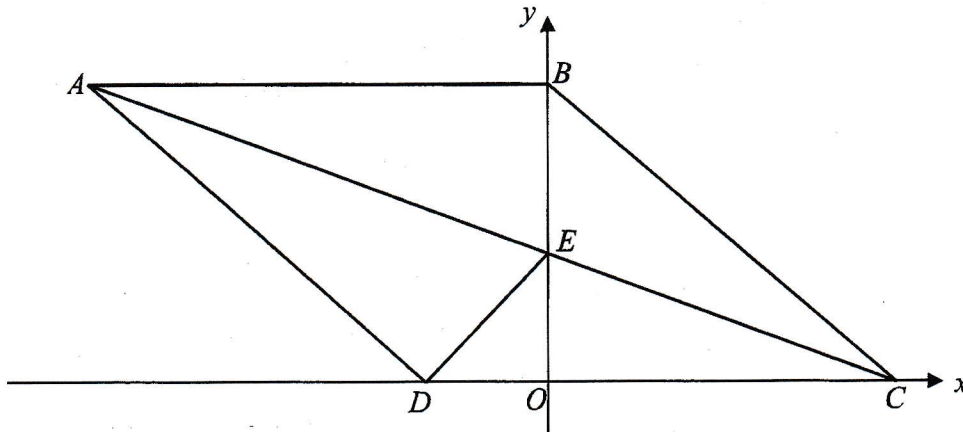

Show that the triangle AEB is congruent to triangle AED . [3]

Answer

$$\begin{aligned}
 AB &= AD && \text{(side of rhombus)} \\
 AE &= AE && \text{(common side)} \\
 \angle BAE &= \angle DAE && \text{(diagonal bisects angle)} \\
 \triangle AEB &\cong \triangle AED && \text{(SAS)}
 \end{aligned}$$

- 12 A box contains 80 paper clips, some of which are grey, some are yellow and the rest are blue.

The probability of drawing a grey clip is $\frac{1}{5}$ and the probability drawing a yellow clip is $\frac{1}{4}$.

- (a) Find the number of blue paper clips.

$$\begin{aligned} \text{Number of blue paper clips} &= \left(1 - \frac{1}{5} - \frac{1}{4}\right) \times 80 \\ &= 44 \end{aligned}$$

Answer 44 [1]

- (b) x blue paper clips are removed from the box so that the probability of drawing a blue clip from the box becomes $\frac{7}{25}$.

Find the value of x .

$$\begin{aligned} \frac{44-x}{80-x} &= \frac{7}{25} \\ 1100 - 25x &= 560 - 7x \\ 18x &= 540 \\ x &= 30 \end{aligned}$$

Answer $x = 30$ [2]

$$13 \quad p = \frac{1}{2} \sqrt{\frac{x^2 - 3y}{x^2}}$$

- (a) Evaluate p when $x = -12$ and $y = 4$, giving your answer correct to two decimal places.

$$\begin{aligned} p &= \frac{1}{2} \sqrt{\frac{(-12)^2 - 3(4)}{(-12)^2}} \\ &= 0.4787 \\ &= 0.48 \end{aligned}$$

Answer $p = \underline{0.48}$ [1]

- (b) Express x in terms of p and y .

$$\begin{aligned} p &= \frac{1}{2} \sqrt{\frac{x^2 - 3y}{x^2}} \\ (2p)^2 &= \frac{x^2 - 3y}{x^2} \\ 4p^2x^2 &= x^2 - 3y \\ x^2 - 4p^2x^2 &= 3y \\ x^2(1 - 4p^2) &= 3y \\ x &= \pm \sqrt{\frac{3y}{1 - 4p^2}} \end{aligned}$$

Answer $x = \pm \sqrt{\frac{3y}{1 - 4p^2}}$ [4]

14 ABC is a right-angled triangle with angle $ABC = 90^\circ$, $AB = 8$ cm and $BC = 15$ cm.

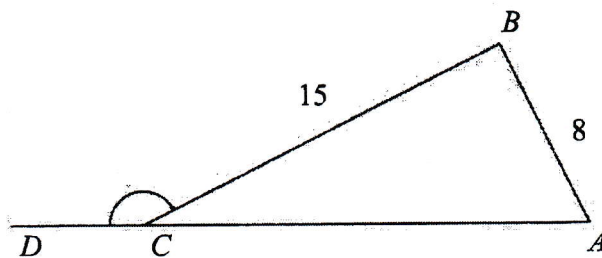

Find the value of $\cos \angle BCD$.

$$AC = \sqrt{15^2 + 8^2}$$

$$= 17$$

$$\cos \angle BCD = -\cos \angle BCA$$

$$= -\frac{15}{17}$$

Answer $\cos \angle BCD = -\frac{15}{17}$ [2]

15 (a) Solve the inequalities $2x + 13 < 4(x + 2) \leq x + 41$.

$$2x + 13 < 4x + 8 \quad \text{and} \quad 4x + 8 \leq x + 41$$

$$2x > 5 \quad \text{and} \quad 3x \leq 33$$

$$x > \frac{5}{2} \quad \text{and} \quad x \leq 11$$

$$\frac{5}{2} < x \leq 11$$

Answer $\frac{5}{2} < x \leq 11$ [3]

(b) Hence list all the prime integer values of x which satisfy the inequalities $2x + 13 < 4(x + 2) \leq x + 41$.

Answer $3, 5, 7, 11$ [1]

- 16 In the diagram, A is the point $(-3, 1)$ and B is the point $(1, -4)$.
The line AC is parallel to the x -axis.

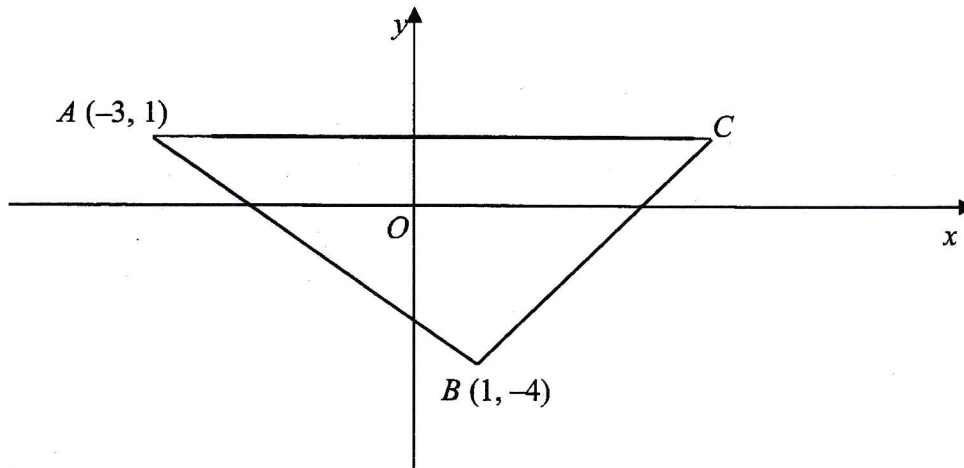

- (a) The equation of the line BC is $y - 2x = -6$. Find the coordinates of point C .

Let $C(x, 1)$

$$\begin{aligned} \text{when } y = 1, \quad 1 - 2x &= -6 \\ 2x &= 7 \\ x &= \frac{7}{2} \end{aligned}$$

Answer $C \left(\frac{7}{2}, 1 \right)$ [1]

- (b) The line l is parallel to AB and passes through point C .
Find the equation of the line l .

$$\begin{aligned} \text{Gradient of } AB &= \frac{1+4}{-3-1} \\ &= -\frac{5}{4} \end{aligned}$$

$$\begin{aligned} \text{Equation of } l: \quad 1 &= -\frac{5}{4} \left(\frac{7}{2} \right) + c \\ c &= 5\frac{3}{8} \end{aligned}$$

$$y = -\frac{5}{4}x + 5\frac{3}{8}$$

Answer $y = -\frac{5}{4}x + 5\frac{3}{8}$ [2]

- 17 In the diagram, BA and BC are tangents to the circle with centre O . BO meets the circle at D , $OA = 10$ cm and $BC = 28$ cm, find

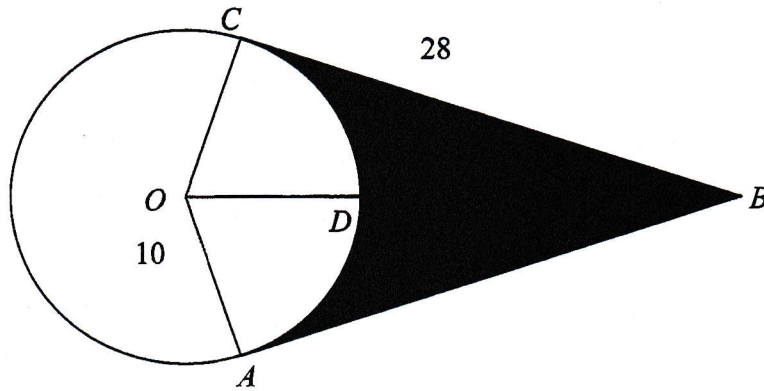

- (a) BD

$$\begin{aligned} BD &= \sqrt{10^2 + 28^2} - 10 \\ &= 19.732 \\ &= 19.7 \end{aligned}$$

Answer 19.7 cm [2]

- (b) The area of the shaded region $ABCD$.

$$\begin{aligned} \text{Area of Quad} &= 2 \times \frac{1}{2} (10)(28) \\ &= 280 \text{ cm}^2 \end{aligned}$$

$$\tan \angle COD = \frac{28}{10}$$

$$\angle COD = 1.2278 \text{ rad} \quad \text{or} \quad 70.346^\circ$$

$$\angle COA = 2.4556 \text{ rad} \quad \text{or} \quad 140.692^\circ$$

$$\begin{aligned} \text{Area of Sector } OADC &= \frac{1}{2} (10)^2 (2.4556) \quad \text{or} \quad \frac{140.692}{360} (\pi)(10)^2 \\ &= 122.78 \end{aligned}$$

$$\begin{aligned} \text{Area of shaded region} &= 280 - 122.78 \\ &= 157.02 \\ &= 157 \text{ cm}^2 \end{aligned}$$

Answer 157 cm² [4]

- 18 21 girls took a 40-metre shuttle run test.
The timings are shown in the stem-and-leaf diagram.

| Stem | Leaf |
|------|-------------|
| 10 | 3 4 5 5 |
| 10 | 6 7 7 8 9 |
| 11 | 0 2 2 2 4 5 |
| 11 | 6 8 9 |
| 12 | 2 3 |
| 12 | 5 |

Key: 10|3 means 10.3 seconds

- (a) Find the median time of the distribution.

Answer 11.2 s [1]

- (b) Find the interquartile range.

$$\begin{aligned} \text{IQR} &= 11.7 - 10.65 \\ &= 1.05 \end{aligned}$$

Answer 1.05 s [2]

- (c) The box-and-whisker plot shows the distribution of the timings obtained by the same group of girls in July 2021.

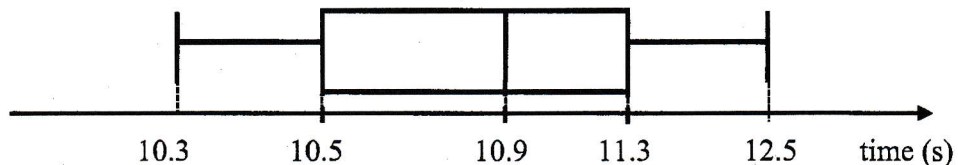

The teacher claims that the performance has improved and is more consistent in July 2021 than in January 2021.
Explain if this statement is true.

The statement is true. The median in July (10.9) is faster than in Jan (11.2)
And the IQR in July is smaller (0.8) than in Jan (1.05)

[2]

- 19 (a) The air resistance, R newtons, is directly proportional to the square of the speed, V m/s, of an object when it is falling.
 The air resistance is 24 newtons at a certain speed.
 Find the air resistance when the speed is increased by 50%.

$$\frac{R_1}{(V_1)^2} = \frac{R_2}{(V_2)^2}$$

$$\frac{R}{(1.5V)^2} = \frac{24}{V^2}$$

$$R = \frac{24}{V^2} \times 1.5V^2$$

$$= 54$$

Answer 54 newtons [3]

- (b) 16 workers can tile 2 rooms in 60 hours.
 How many workers are needed if 5 rooms are to be tiled in 72 hours?

| Workers x Time | | Rooms |
|----------------|----------|-------|
| 16 men | x 60 hrs | 2 |
| W men | x 72 hrs | 5 |

$$\frac{72W}{5} = \frac{16 \times 60}{2}$$

$$W = 33\frac{1}{2}$$

Answer 34 workers [2]

- 20 (a) In the space below, construct a quadrilateral such that $PS = 7$ cm, angle $QRS = 110^\circ$ and angle PSR is an acute angle. QR and QP have already been drawn. [2]

Answer

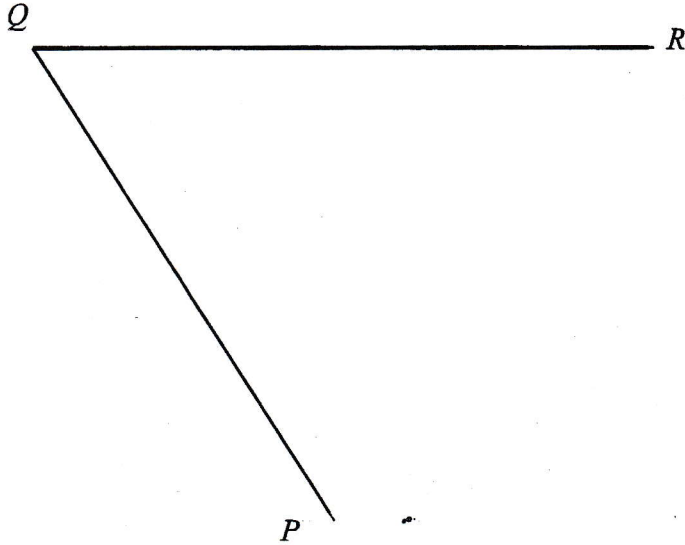

- (b) Construct the perpendicular bisector of PQ . [1]
- (c) The perpendicular bisector in (b) intersects the line QR at T . Measure the angle QTP .

Answer _____ ° [1]

- 21 The diagram shows the speed-time graph for Sriya's 100 metre run during her school's sports day.

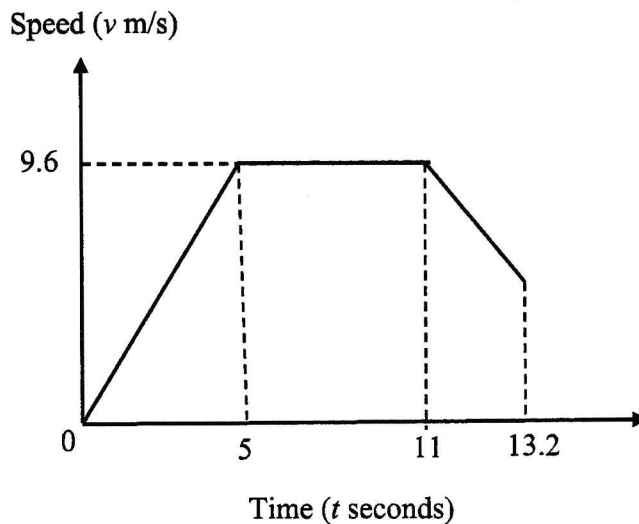

In the first 5 seconds, Sriya's accelerated uniformly to a speed of 9.6 m/s. She maintained her speed for the next 6 seconds and slowed down over the last 2.2 seconds. She crossed the finishing line after 13.2 seconds.

- (a) Calculate Sriya's acceleration 3 seconds after the race started.

$$\begin{aligned} \text{Acceleration} &= \frac{9.6}{5} \\ &= 1.92 \end{aligned}$$

Answer 1.92 m/s² [1]

- (b) Calculate the speed when she crossed the finishing line..

Let the speed be x m/s

$$100 = \frac{1}{2}(11+6)(9.6) + \frac{1}{2}(9.6+x)(2.2)$$

$$18.4 = \frac{1}{2}(9.6+x)(2.2)$$

$$\begin{aligned} x &= 7.1273 \\ &= 7.13 \end{aligned}$$

Answer 7.13 m/s [2]

- (c) The distance-time graph for another runner, Ella, in the same race is shown on the grid below.
 Ella accelerated uniformly to a speed of 10.2 m/s and then maintained her speed until she crossed the finishing line.
 She ran a distance of 29.7 m in the first 6 seconds.

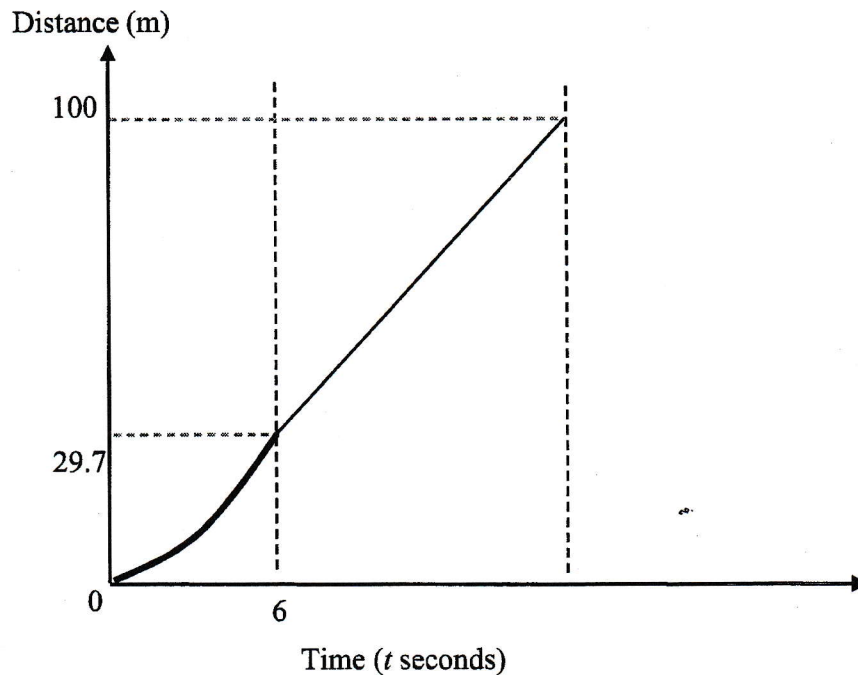

Who do you think won the race? Justify your answer.

$$\begin{aligned} \text{Time taken to finish the last } 70.3 \text{ m} &= \frac{70.3}{10.2} \\ &= 6.8921 \text{ sec} \end{aligned}$$

$$\begin{aligned} \text{Therefore total time taken} &= 6 + 6.8921 \\ &= 12.8921 \text{ sec} \\ &= 12.9 \text{ sec} \end{aligned}$$

Ella won the race as her time (12.9) is faster than Sriya (13.2)

End of Paper

BLANK PAGE



CEDAR GLEN S' SECONDARY SCHOOL
Preliminary Examination
Secondary Four

CANDIDATE
NAME

_____ Sec 4 () Reg. No: ()

CENTRE
NUMBER

| | | | |
|--|--|--|--|
| | | | |
|--|--|--|--|

INDEX
NUMBER

| | | | |
|--|--|--|--|
| | | | |
|--|--|--|--|

MATHEMATICS

Paper 2

4048/02

1 September 2021

2 hours 30 minutes

Candidates answer on the Question Paper.

Additional Materials: Nil

READ THESE INSTRUCTIONS FIRST

Write your Centre number, index number and name on all the work you hand in.
Write in dark blue or black pen.
You may use an HB pencil for any diagrams or graphs.
Do not use staples, paper clips, highlighters, glue or correction fluid.
DO NOT WRITE IN ANY BARCODES.

Answer **all** the questions.

Give non-exact numerical answers correct to 3 significant figures, or 1 decimal place in the case of angles in degrees, unless a different level of accuracy is specified in the question.
The use of an approved scientific calculator is expected, where appropriate.
You are reminded of the need for clear presentation in your answers.

At the end of the examination, fasten all your work securely together.
The number of marks is given in brackets [] at the end of each question or part question.

The total number of marks for this paper is 100.

| |
|----------------------------|
| F. r Examiner's Use |
| 100 |

Mathematical Formulae*Compound interest*

$$\text{Total amount} = P \left(1 + \frac{r}{100} \right)^n$$

Mensuration

$$\text{Curved surface area of a cone} = \pi r l$$

$$\text{Surface area of a sphere} = 4\pi r^2$$

$$\text{Volume of a cone} = \frac{1}{3} \pi r^2 h$$

$$\text{Volume of a sphere} = \frac{4}{3} \pi r^3$$

$$\text{Area of triangle } ABC = \frac{1}{2} ab \sin C$$

$$\text{Arc length} = r\theta, \text{ where } \theta \text{ is in radians}$$

$$\text{Sector area} = \frac{1}{2} r^2 \theta, \text{ where } \theta \text{ is in radians}$$

Trigonometry

$$\frac{a}{\sin A} = \frac{b}{\sin B} = \frac{c}{\sin C}$$

$$a^2 = b^2 + c^2 - 2bc \cos A$$

Statistics

$$\text{Mean} = \frac{\sum fx}{\sum f}$$

$$\text{Standard deviation} = \sqrt{\frac{\sum fx^2}{\sum f} - \left(\frac{\sum fx}{\sum f} \right)^2}$$

Answer all the questions.

1 (a) Simplify

(i) $\sqrt{\frac{1}{a}} \times b \div \left(\frac{2}{ab}\right)^{-2}$,

Answer [3]

(ii) $\frac{4x^2 - 36}{2x^2 - 20x + 42}$.

Answer [3]

4

(b) Solve these simultaneous equations.

$$2x - 3y = 19$$

$$3x + 2y = -4$$

Answer $x =$
 $y =$ [3]

(c) It is given that $4^p = 5$, $5^{2q} = 6$, $6^{3r} = 7$ and $7^{4s} = 8$.
Find the exact value of $pqrs$.

Answer $pqrs =$ [3]

- 2 (a) The cost of manufacturing a sofa is \$1500.
It is sold to a retailer at a profit of 15% of the cost.

(i) Calculate the price the retailer paid for the sofa.

Answer \$..... [1]

(ii) At a furniture fair, the retailer then sold the sofa to a customer at \$2250.
Calculate the retailer's profit for the sale of the sofa as a percentage of the selling price.

Answer% [2]

- (b) John changed S\$ 3500 for US Dollar (US\$) at a bank, for his trip to the United States. Upon his return, he still had US\$ 78 left in his wallet.

The table below shows the exchange rate between Singapore dollar (S\$) and US dollar (US\$) at the bank upon his return.

| Currency | Unit | Singapore Dollar (S\$) | |
|------------------|------|------------------------|--------|
| | | Selling | Buying |
| US Dollar (US\$) | 1 | 1.38 | 1.34 |

Calculate the amount he spent in Singapore dollar (S\$) for his trip to the United States.

Answer S\$..... [2]

- (c) The cash price of a gaming device is \$ 710.
Jolene buys this gaming device on hire purchase and pays a 30% deposit.

The following shows the different hire purchase schemes with a repayment period of 5 years that are offered to her by the finance company.

Scheme A: Compound interest of 2.5% per annum

Scheme B: Simple interest of 2.6% per annum

Explain and justify, with clear mathematical working, which hire purchase scheme should Jolene take up.

.....
.....
.....

[5]

- 3 $\overline{AB} = \begin{pmatrix} 7 \\ 1 \end{pmatrix}$, D is the point $(-2, 1)$ and E is $(h, 6)$.

(a) Express \overline{DE} as a column vector.

Answer [1]

(b) $\overline{DE} = \overline{AB}$
Find the possible values of h .

Answer $h = \dots\dots\dots$ or $\dots\dots\dots$ [2]

(iii) Explain why one of the solutions in (b)(ii) must be rejected as the width of the rectangle.

Answer

[2]

(iv) Hence, find the perimeter of the rectangle.

Answer cm [1]

5

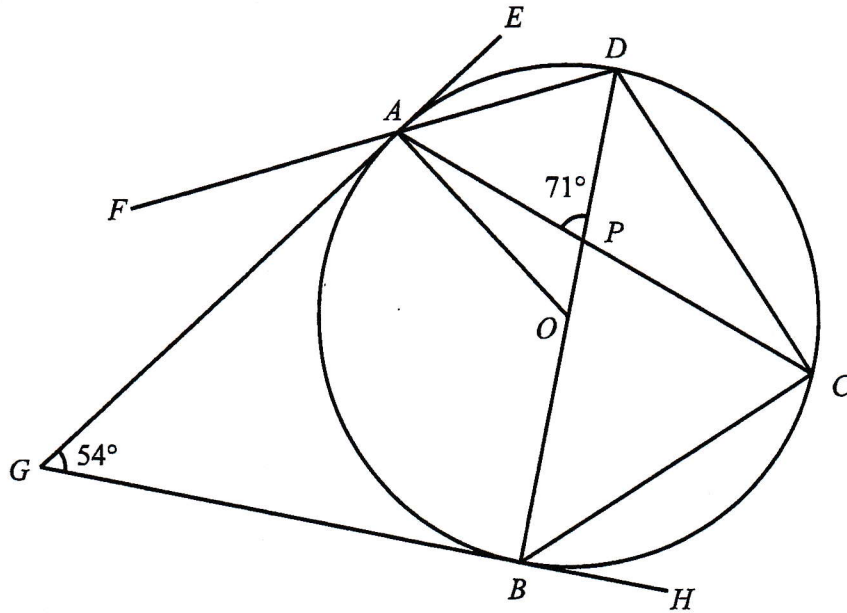

In the diagram, A, B, C and D are points on the circle with centre O . AG and BG are tangents to the circle. GAE, FAD and GBH are straight lines. Angle $APD = 71^\circ$, angle $AGB = 54^\circ$.

- (a) Explain why a circle can be drawn passing through the points A, O, B and G . State the centre of this circle.

[2]

- (b) Stating your reasons clearly, find

- (i) angle AOB ,

Answer

[1]

(ii) angle DCA ,

Answer [2]

(iii) angle PBC ,

Answer [2]

(iv) angle CBH .

Answer [1]

- 6 (a) The histogram below shows the distribution of the scores of the participants from Potong Pasir Secondary School in a current affairs quiz.

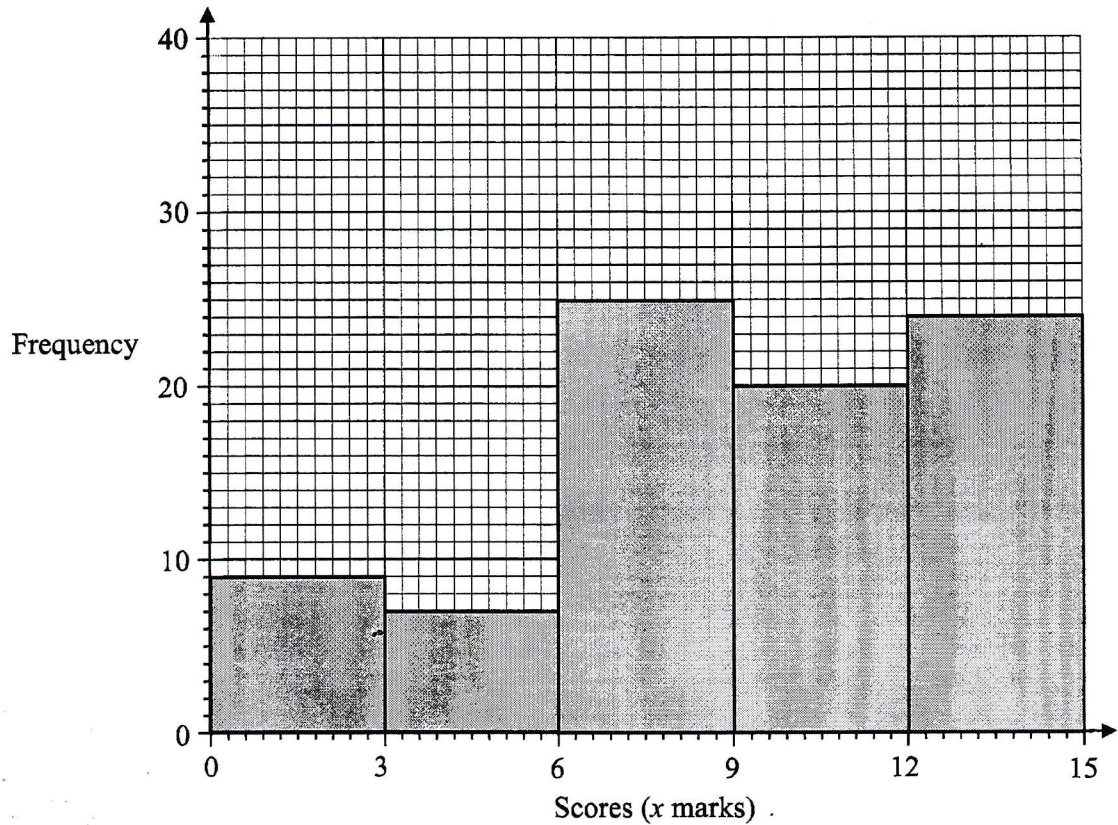

- (i) Calculate the total number of participants from Potong Pasir Secondary School.

Answer [1]

- (ii) Calculate an estimate of the mean score.

Answer [1]

- (iii) Calculate an estimate of the standard deviation.

Answer [1]

- (iv) Explain why the mean and standard deviation are estimates.

Answer

[1]

- (v) State the interval that contains the median mark.

Answer

[1]

- (vi) The organiser then decides to present the awards for the quiz according to the following table.

| Scores (x marks) | Category of Award |
|---------------------|------------------------------|
| $12 < x \leq 15$ | Gold |
| $9 < x \leq 12$ | Silver |
| $6 < x \leq 9$ | Bronze |
| $0 < x \leq 6$ | Certificate of Participation |

Calculate the percentage of students who attained at least a Silver Award.

Answer% [1]

- 6 (b) Box *A* contains 3 cups of chocolate ice-cream and 4 cups of strawberry ice-cream. Box *B* contains 2 cups of chocolate ice-cream, 3 cups of strawberry ice-cream and 4 cups of vanilla ice-cream.

A cup of ice-cream is selected at random from box *A*.
It is then placed in box *B* before a cup of ice-cream is selected at random from box *B*.

- (i) Draw a tree diagram to show the probabilities of the possible outcomes.

[3]

- (ii) Find, as a fraction in its simplest form, the probability that

- (a) the two cups of ice-cream selected are of the same flavour,

Answer [2]

- (b) the second cup of ice-cream selected is not chocolate.

Answer [2]

- 7 (a) $\xi = \{\text{integers } x : 2 < x \leq 12\}$
 $A = \{\text{prime numbers}\}$
 $B = \{\text{factors of } 12\}$
 $C = \{\text{greater than } \sqrt{100}\}$

List the elements in

(i) $A \cap C'$,

Answer [1]

(ii) $A' \cup B$.

Answer [1]

- (b) It is given that $M \cap N = \phi$ and $L \subset N$.
 Complete and label the Venn diagram below for the sets L , M and N .

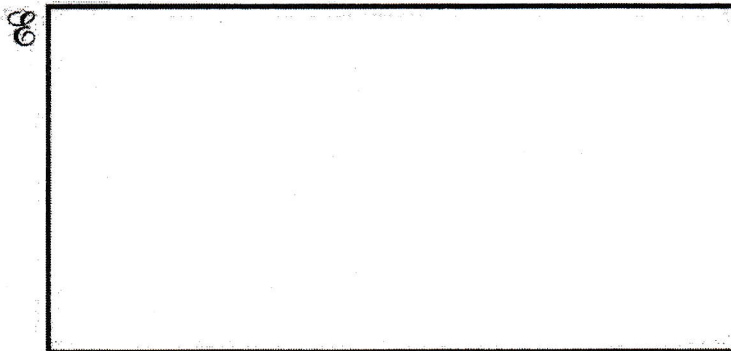

[2]

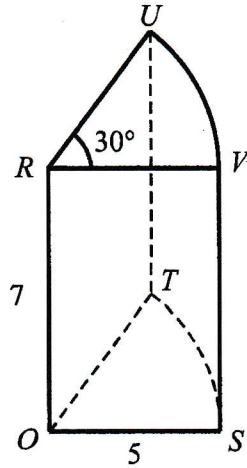

The figure above shows a solid.
 The cross-section of the solid is a sector of a circle of radius 5 cm and angle 30° .
 The horizontal cross-sections, OST and RVU , are 7 cm apart.
 S, T, U and V lie on the curved surface of the solid.
 The lines OR, TU and SV are vertical.

(a) Find

(i) the area of the curved surface $STUV$ in terms of π ,

Answer cm^2 [2]

(ii) the angle UST .

Answer [3]

- (b) Another solid geometrically similar to the given figure has a base radius of 3 cm. Find the ratio of the volume of the smaller solid to the volume of the larger one.

Answer [1]

9

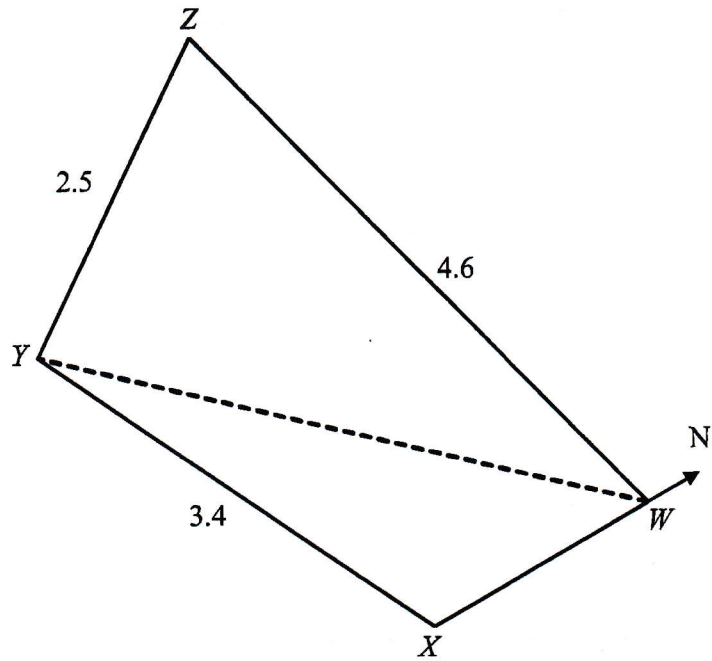

The diagram shows part of a map of a small town.
 Joel's house is located at point W , the childcare centre at point X , the park at point Y and the shopping mall at point Z .

$WZ = 4.6$ km, $YZ = 2.5$ km and $XY = 3.4$ km

The bearing of W from Y is 043.4° and the bearing of X from Y is 064.1° .

- (a) Find the bearing of park Y from childcare centre X .

Answer

[1]

- (b) Find the distance of park Y from Joel's house W .

Answer

..... km [3]

- (c) Find the bearing of the shopping mall Z from Joel's house W .

Answer [3]

- (d) Find the area of the triangle WYZ .

Answer km² [2]

- (e) The **smallest** possible angle of depression of a point on the path WY from the top of the shopping mall Z is 25° .

Find the height of shopping mall Z , giving your answer to the nearest metre.

Answer m [2]

10 (a) Complete the table of values for $y = 10 - \frac{x^2}{2} - \frac{4}{x}$.

| | | | | | | | | |
|---|-----|-----|-----|---|-----|---|-------|------|
| x | 0.5 | 0.7 | 1 | 2 | 3 | 4 | 5 | 6 |
| y | 1.9 | 4.0 | 5.5 | 6 | 4.2 | 1 | _____ | -8.7 |

[1]

(b) On the grid opposite, draw the graph of $y = 10 - \frac{x^2}{2} - \frac{4}{x}$ for $0.5 \leq x \leq 6$. [3]

(c) By drawing a tangent, find the gradient of the curve at (2, 6).

Answer [2]

(d) By drawing suitable straight lines, find the x-coordinate of the point(s) on the curve at which the gradient of the tangent is 3, in the range $0.5 \leq x \leq 6$.

Drawing of // lines with gradient 3

Answer $x =$ [2]

(e) Use your graph to find the solutions of the equation $x^3 - x^2 - 14x + 8 = 0$ in the range $0.5 \leq x \leq 6$.

Answer $x =$ or [3]

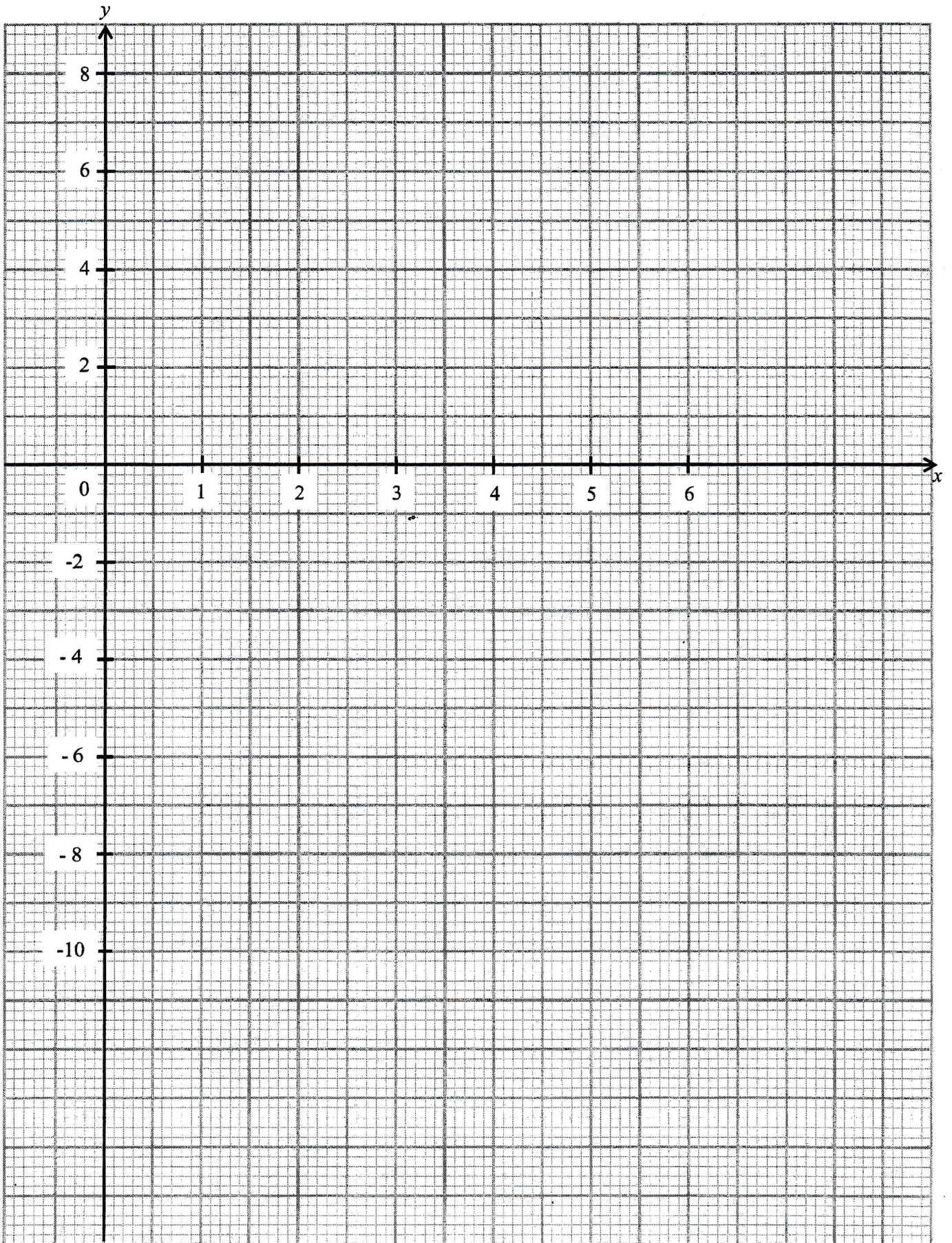

11 Here is some information about a grain storage bin.

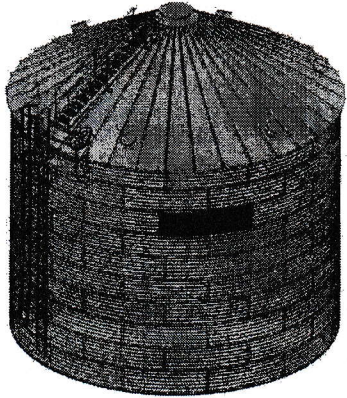
| | |
|---|--|
| <p>Grain Storage Bin</p> |  |
| <p>Height (h): 6880 mm</p> | |
| <p>Diameter (d): 4550 mm</p> | |
| <p>Mass: 1100 kg</p> | |
| <p>Safety information: The bin can be filled to a maximum of 85% of its total volume.</p> | |

In this question, the grain storage bin can be modelled as a right cylinder with a right conical top. The height of the conical top is half the radius of the bin.

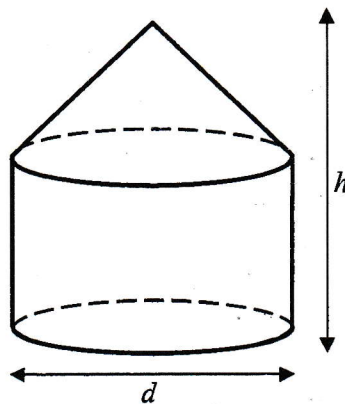

(a) Work out the area, in square metres, of the base of the grain storage bin.

Answer m² [1]

(b) Work out the volume, in cubic metres, of the grain storage bin.

Answer m³ [3]

(c)

| |
|--|
| <p style="text-align: center;">Useful information</p> <ul style="list-style-type: none">• Density of grain stored: 410 kg/m^3• 1000 kg is equivalent to 9.81 kN |
|--|

The storage bin is never filled to more than its safe volume. It will need a special load-bearing support structure if its total weight per square metre, on the ground beneath, is greater than 20 kN/m^2 .

Given that the model is an underestimation of the actual storage capacity of the bin, does the bin need a special load-bearing support structure? Justify your decision with calculations.

.....

.....

.....

[6]

End of Paper

BLANK PAGE

ANS

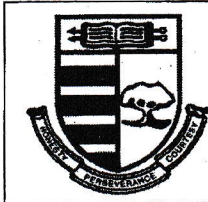

CEDAR GIRLS' SECONDARY SCHOOL
Preliminary Examination
Secondary Four

CANDIDATE
NAME

Worked Solutions

Sec 4 () Reg. No: ()

CENTRE
NUMBER

| | | | |
|--|--|--|--|
| | | | |
|--|--|--|--|

INDEX
NUMBER

| | | | |
|--|--|--|--|
| | | | |
|--|--|--|--|

MATHEMATICS

Paper 2

4048/02

1 September 2021

2 hours 30 minutes

Candidates answer on the Question Paper.

Additional Materials: Nil

READ THESE INSTRUCTIONS FIRST

Write your Centre number, index number and name on all the work you hand in.
Write in dark blue or black pen.
You may use an HB pencil for any diagrams or graphs.
Do not use staples, paper clips, highlighters, glue or correction fluid.
DO NOT WRITE IN ANY BARCODES.

Answer **all** the questions.

Give non-exact numerical answers correct to 3 significant figures, or 1 decimal place in the case of angles in degrees, unless a different level of accuracy is specified in the question.
The use of an approved scientific calculator is expected, where appropriate.
You are reminded of the need for clear presentation in your answers.

At the end of the examination, fasten all your work securely together.
The number of marks is given in brackets [] at the end of each question or part question.

The total number of marks for this paper is 100.

| |
|---------------------------|
| For Examiner's Use |
| 100 |

Mathematical Formulae*Compound interest*

$$\text{Total amount} = P \left(1 + \frac{r}{100} \right)^n$$

Mensuration

$$\text{Curved surface area of a cone} = \pi r l$$

$$\text{Surface area of a sphere} = 4\pi r^2$$

$$\text{Volume of a cone} = \frac{1}{3} \pi r^2 h$$

$$\text{Volume of a sphere} = \frac{4}{3} \pi r^3$$

$$\text{Area of triangle } ABC = \frac{1}{2} ab \sin C$$

$$\text{Arc length} = r\theta, \text{ where } \theta \text{ is in radians}$$

$$\text{Sector area} = \frac{1}{2} r^2 \theta, \text{ where } \theta \text{ is in radians}$$

Trigonometry

$$\frac{a}{\sin A} = \frac{b}{\sin B} = \frac{c}{\sin C}$$

$$a^2 = b^2 + c^2 - 2bc \cos A$$

Statistics

$$\text{Mean} = \frac{\sum fx}{\sum f}$$

$$\text{Standard deviation} = \sqrt{\frac{\sum fx^2}{\sum f} - \left(\frac{\sum fx}{\sum f} \right)^2}$$

Answer all the questions.

1 (a) Simplify

$$(i) \sqrt{\frac{1}{a}} \times b \div \left(\frac{2}{ab}\right)^{-2},$$

$$\begin{aligned} & \sqrt{\frac{1}{a}} \times b \div \left(\frac{2}{ab}\right)^{-2} \\ &= \frac{b}{\sqrt{a}} \times \frac{4}{a^2 b^2} \\ &= \frac{4}{a^{2.5} b} \text{ or } \frac{4}{a^{\frac{5}{2}} b} \text{ or } \frac{4}{a^{2\frac{1}{2}} b} \text{ or } \frac{4}{b\sqrt{a^5}} \text{ or } \frac{4}{\sqrt{a^5} b} \end{aligned}$$

Answer [3]

$$(ii) \frac{4x^2 - 36}{2x^2 - 20x + 42}$$

$$\begin{aligned} & \frac{4x^2 - 36}{2x^2 - 20x + 42} \\ &= \frac{4(x+3)(x-3)}{2(x-7)(x-3)} \\ &= \frac{2(x+3)}{x-7} \text{ or } \frac{2x+6}{x-7} \end{aligned}$$

Answer [3]

(b) Solve these simultaneous equations.

$$2x - 3y = 19$$

$$3x + 2y = -4$$

Substitute $x = \frac{19+3y}{2}$ into $3x + 2y = -4$,

$$3\left(\frac{19+3y}{2}\right) + 2y = -4$$

$$\boxed{y = -5}$$

$$x = \frac{19+3(-5)}{2}$$

$$\boxed{x = 2}$$

Answer $x =$
 $y =$ [3]

(c) It is given that $4^p = 5$, $5^{2q} = 6$, $6^{3r} = 7$ and $7^{4s} = 8$.
 Find the exact value of $pqrs$.

$$4^{24pqrs} = 8$$

$$2^{48pqrs} = 2^3$$

$$48pqrs = 3$$

$$\boxed{pqrs = \frac{1}{16}}$$

Answer $pqrs =$ [3]

- 2 (a) The cost of manufacturing a sofa is \$1500.
It is sold to a retailer at a profit of 15% of the cost.

(i) Calculate the price the retailer paid for the sofa.

$$\$1500 \times 1.15 = \boxed{\$1725}$$

Answer \$..... [1]

(ii) At a furniture fair, the retailer then sold the sofa to a customer at \$2250.
Calculate the retailer's profit for the sale of the sofa as a percentage of the selling price.

$$\frac{\$2250 - \$1725}{\$2250} \times 100\%$$

$$= \boxed{23\frac{1}{3}\%}$$

Answer% [2]

- (b) John changed S\$ 3500 for US Dollar (US\$) at a bank, for his trip to the United States. Upon his return, he still had US\$ 78 left in his wallet.

The table below shows the exchange rate between Singapore dollar (S\$) and US dollar (US\$) at the bank upon his return.

| Currency | Unit | Singapore Dollar (S\$) | |
|------------------|------|------------------------|--------|
| | | Selling | Buying |
| US Dollar (US\$) | 1 | 1.38 | 1.34 |

Calculate the amount he spent in Singapore dollar (S\$) for his trip to the United States.

$$\begin{aligned} & \text{US\$ } 78 \\ & = \text{S\$ } (78 \times 1.34) \\ & = \text{S\$ } 104.52 \end{aligned}$$

$$\begin{aligned} & \text{Amount spent in S\$ for his trip to US} \\ & = \text{S\$ } 3500 - \text{S\$ } 104.52 \\ & = \boxed{\text{S\$ } 3395.48} \end{aligned}$$

Answer S\$..... [2]

- (c) The cash price of a gaming device is \$ 710.
Jolene buys this gaming device on hire purchase and pays a 30% deposit.

The following shows the different hire purchase schemes with a repayment period of 5 years that are offered to her by the finance company.

Scheme A: Compound interest of 2.5% per annum

Scheme B: Simple interest of 2.6% per annum

Explain and justify, with clear mathematical working, which hire purchase scheme should Jolene take up.

Answer

$$\begin{aligned} \text{Loan} \\ &= \$710 \times 0.7 \\ &= \$497 \end{aligned}$$

Total Repayment Amount for Scheme A

$$\begin{aligned} &= \$497 \times \left(1 + \frac{2.5}{100}\right)^5 \\ &= \$562.31 \text{ (nearest cent)} \end{aligned}$$

Total Repayment Amount for Scheme B

$$\begin{aligned} &= \$497 + \left(\$497 \times \frac{2.6}{100} \times 5\right) \\ &= \$561.61 \end{aligned}$$

Jolene should take up scheme B as the total repayment amount / interest payable on the hire purchase is lower for scheme B than scheme A.

.....
.....
.....

[5]

3 $\overline{AB} = \begin{pmatrix} 7 \\ 1 \end{pmatrix}$, D is the point $(-2, 1)$ and E is $(h, 6)$.

(a) Express \overline{DE} as a column vector.

$$\begin{aligned} \overline{DE} &= \overline{OE} - \overline{OD} \\ &= \begin{pmatrix} h \\ 6 \end{pmatrix} - \begin{pmatrix} -2 \\ 1 \end{pmatrix} \\ &= \begin{pmatrix} h+2 \\ 5 \end{pmatrix} \end{aligned}$$

Answer [1]

(b) $DE = AB$
Find the possible values of h .

$$\begin{aligned} \sqrt{(h+2)^2 + 5^2} &= \sqrt{7^2 + 1^2} \\ (h+2)^2 &= 25 \\ h+2 &= \pm 5 \\ \boxed{h=3 \text{ or } h=-7} \end{aligned}$$

Answer $h = \dots$ or \dots [2]

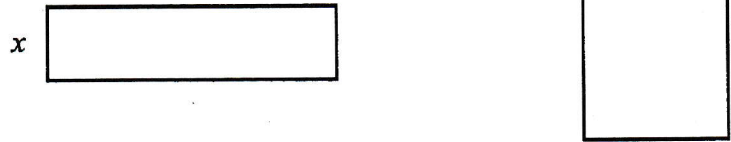

A piece of wire, 44 cm in length, is cut into two parts.
 One part is used to make a rectangle and the other a square.
 The length of the rectangle is 200% longer than its width.
 The width of the rectangle is x centimetres.

- (a) (i) Write down an expression, in terms of x , for the length of the rectangle.

Length of rectangle = $3x$ cm

Answer cm [1]

- (ii) Find, and simplify, an expression, in terms of x , for the length of the square.

Length of the square
 $= \frac{1}{4}[44 - 2(3x + x)]$
 $= 11 - 2x$ cm

Answer cm [2]

The area of the rectangle is 1 cm^2 smaller than the area of the square.

- (b) (i) Form an equation in x and show that it reduces to $x^2 - 44x + 120 = 0$.

Answer
 $3x(x) = (11 - 2x)^2 - 1$
 $3x^2 = 121 - 44x + 4x^2 - 1$
 $x^2 - 44x + 120 = 0$

[3]

- (ii) Solve the equation $x^2 - 44x + 120 = 0$, giving each solution correct to 5 significant figures.

$x = \frac{44 \pm \sqrt{(-44)^2 - 4(1)(120)}}{2(1)}$
 $x = 2.9212 \text{ or } 41.079$

Answer $x = \dots\dots\dots$ or $\dots\dots\dots$ [3]

(iii) Explain why one of the solutions in (b)(ii) must be rejected as the width of the rectangle.

Answer $x = 41.079$ is rejected as the length of the rectangle becomes $3(41.079) = 123.237$ cm which exceeds the total length of wire from which it is formed.

..... [2]

(iv) Hence, find the perimeter of the rectangle.

Perimeter of rectangle = $8 \times (2.9212) = 23.4$ cm (to 3 s.f.)

Answer cm [1]

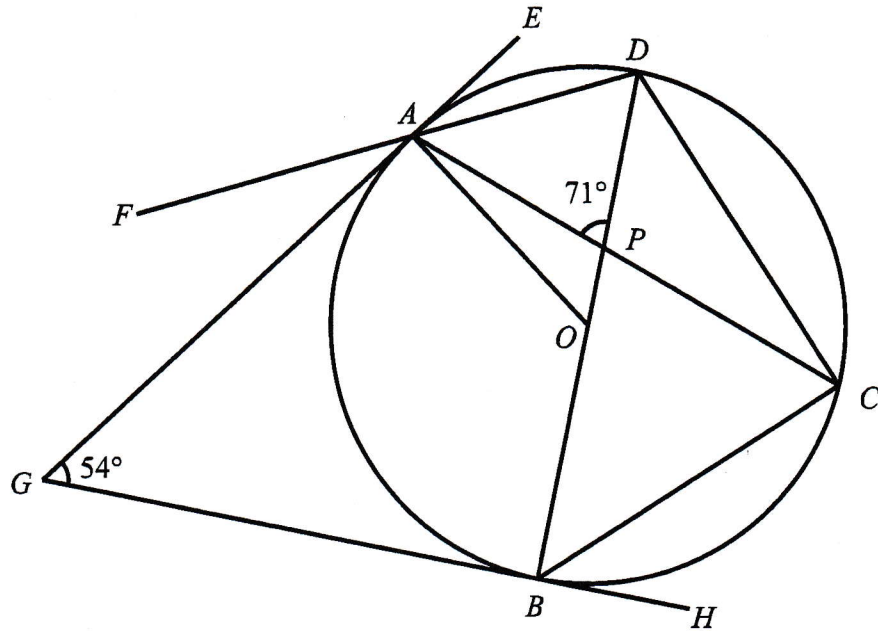

In the diagram, A, B, C and D are points on the circle with centre O . AG and BG are tangents to the circle. GAE, FAD and GBH are straight lines. Angle $APD = 71^\circ$, angle $AGB = 54^\circ$.

- (a) Explain why a circle can be drawn passing through the points A, O, B and G . State the centre of this circle.

Answer

$$\angle GAO = 90^\circ \text{ (tan } \perp \text{ rad)}$$

$$\angle GBO = 90^\circ \text{ (tan } \perp \text{ rad)}$$

A circle with diameter GO passes through points A, O, B and G . (\angle in a semicircle). Its centre is on the mid-point of GO .

[2]

- (b) Stating your reasons clearly, find

- (i) angle AOB ,

Angle AOB

$$= 360^\circ - 90^\circ - 90^\circ - 54^\circ \text{ (angle sum of quad.)}$$

$$= \boxed{126^\circ}$$

Answer

[1]

(ii) angle DCA ,

$$\begin{aligned}
 &\text{Angle } DCA \\
 &= \frac{1}{2} \text{ Angle } AOD \text{ (angle at centre = } 2 \times \text{ angle at circumference)} \\
 &= \frac{1}{2} (180^\circ - \text{Angle } AOB) \text{ (adj. angles on a str. line)} \\
 &= \frac{1}{2} (180^\circ - 126^\circ) \\
 &= \boxed{27^\circ}
 \end{aligned}$$

Answer [2]

(iii) angle PBC ,

$$\begin{aligned}
 &\text{Angle } ACB \\
 &= \frac{1}{2} \text{ Angle } AOB \text{ (angle at centre = } 2 \times \text{ angle at circumference)} \\
 &= 63^\circ
 \end{aligned}$$

$$\begin{aligned}
 &\text{Angle } BPC \\
 &= \text{Angle } APD \text{ (vert. opp. angles)} \\
 &= 71^\circ
 \end{aligned}$$

$$\begin{aligned}
 &\text{Angle } PBC \\
 &= 180^\circ - 63^\circ - 71^\circ \text{ (angle sum of triangle).} \\
 &= \boxed{46^\circ}
 \end{aligned}$$

Answer [2]

(iv) angle CBH .

$$\begin{aligned}
 &\text{Angle } PBH = 90^\circ \text{ (tan } \perp \text{ rad)} \\
 &\text{Angle } CBH \\
 &= 90^\circ - 46^\circ \\
 &= \boxed{44^\circ}
 \end{aligned}$$

Answer [1]

- 6 (a) The histogram below shows the distribution of the scores of the participants from Potong Pasir Secondary School in a current affairs quiz.

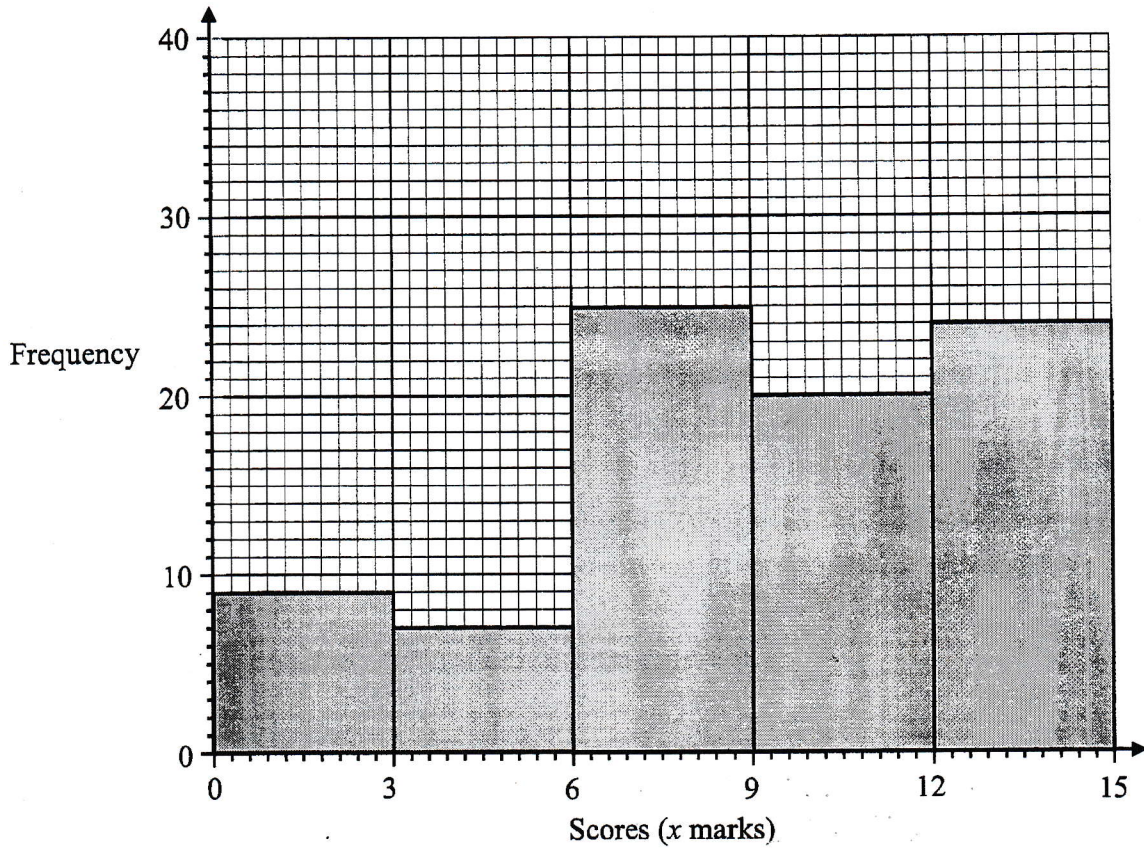

- (i) Calculate the total number of participants from Potong Pasir Secondary School.

Answer 85 [1]

- (ii) Calculate an estimate of the mean score.

Answer 9.02 [1]

- (iii) Calculate an estimate of the standard deviation.

Answer 3.81 [1]

(iv) Explain why the mean and standard deviation are estimates.

Answer

We assumed the mid-value of each interval as the representative value for the scores in the calculation of mean and standard deviation. [1]

(v) State the interval that contains the median mark.

Answer $9 \text{ to } 12$ **or** $9 - 12$ **or** $9 < x \leq 12$ [1]

(vi) The organiser then decides to present the awards for the quiz according to the following table.

| Scores (x marks) | Category of Award |
|---------------------|------------------------------|
| $12 < x \leq 15$ | Gold |
| $9 < x \leq 12$ | Silver |
| $6 < x \leq 9$ | Bronze |
| $0 < x \leq 6$ | Certificate of Participation |

Calculate the percentage of students who attained at least a Silver Award.

$$\frac{44}{85} \times 100\% = 51\frac{13}{17}\%$$

Answer% [1]

- 6 (b) Box A contains 3 cups of chocolate ice-cream and 4 cups of strawberry ice-cream. Box B contains 2 cups of chocolate ice-cream, 3 cups of strawberry ice-cream and 4 cups of vanilla ice-cream.

A cup of ice-cream is selected at random from box A. It is then placed in box B before a cup of ice-cream is selected at random from box B.

- (i) Draw a tree diagram to show the probabilities of the possible outcomes.

Answer

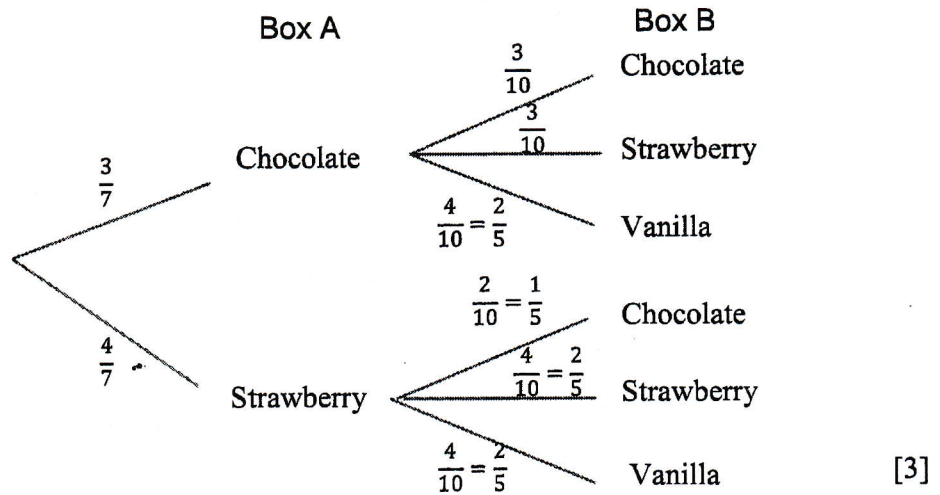

- (ii) Find, as a fraction in its simplest form, the probability that

- (a) the two cups of ice-cream selected are of the same flavour,

$$\left(\frac{3}{7} \times \frac{3}{10}\right) + \left(\frac{4}{7} \times \frac{4}{10}\right)$$

$$= \frac{5}{14}$$

Answer [2]

- (b) the second cup of ice-cream selected is not chocolate.

$$\left(\frac{3}{7} \times \frac{7}{10}\right) + \left(\frac{4}{7} \times \frac{8}{10}\right)$$

$$= \frac{53}{70}$$

Answer [2]

- 7 (a) $\xi = \{\text{integers } x : 2 < x \leq 12\}$
 $A = \{\text{prime numbers}\}$
 $B = \{\text{factors of } 12\}$
 $C = \{\text{greater than } \sqrt{100}\}$

List the elements in

(i) $A \cap C'$,

$A \cap C' = \boxed{\{3, 5, 7\}}$

Answer [1]

(ii) $A' \cup B$.

$A' \cup B = \boxed{\{3, 4, 6, 8, 9, 10, 12\}}$

Answer [1]

- (b) It is given that $M \cap N = \phi$ and $L \subset N$.
 Complete and label the Venn diagram below for the sets L , M and N .

Answer

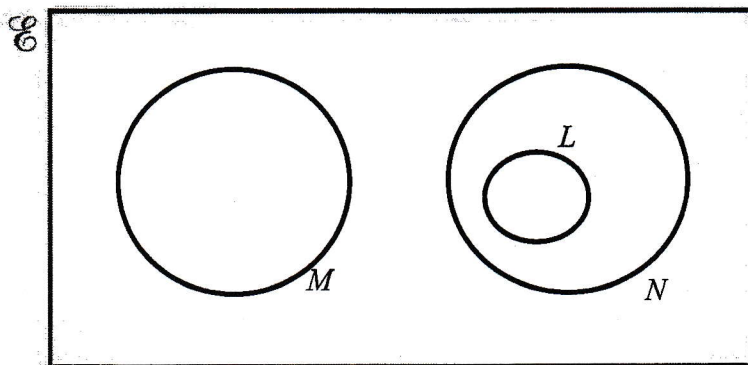

[2]

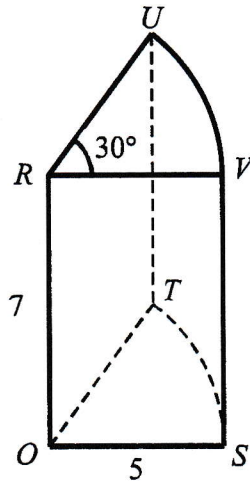

The figure above shows a solid.
 The cross-section of the solid is a sector of a circle of radius 5 cm and angle 30° .
 The horizontal cross-sections, OST and RVU , are 7 cm apart.
 S, T, U and V lie on the curved surface of the solid.
 The lines OR, TU and SV are vertical.

(a) Find

(i) the area of the curved surface $STUV$ in terms of π ,

$$\text{Length of arc } UV = \frac{5\pi}{6} \text{ cm}$$

$$\begin{aligned} \text{Curved surface area } STUV &= \frac{5\pi}{6} \times 7 \\ &= \boxed{\frac{35\pi}{6}} \text{ cm}^2 \end{aligned}$$

Answer cm² [2]

(ii) the angle UST .

$$\begin{aligned} \frac{5}{\sin 75^\circ} &= \frac{ST}{\sin 30^\circ} \\ ST &= 2.5882 \text{ (to 5 s.f.)} \end{aligned}$$

$$\begin{aligned} \tan \angle UST &= \frac{7}{2.5882} \\ \angle UST &= 69.708^\circ \text{ (to 3 d.p.)} \\ \angle UST &= \boxed{69.7^\circ} \text{ (to 1 d.p.)} \end{aligned}$$

Answer [3]

- (b) Another solid geometrically similar to the given figure has a base radius of 3 cm. Find the ratio of the volume of the smaller solid to the volume of the larger one.

$$\left(\frac{3}{5}\right)^3 = \boxed{27 : 125}$$

Answer [1]

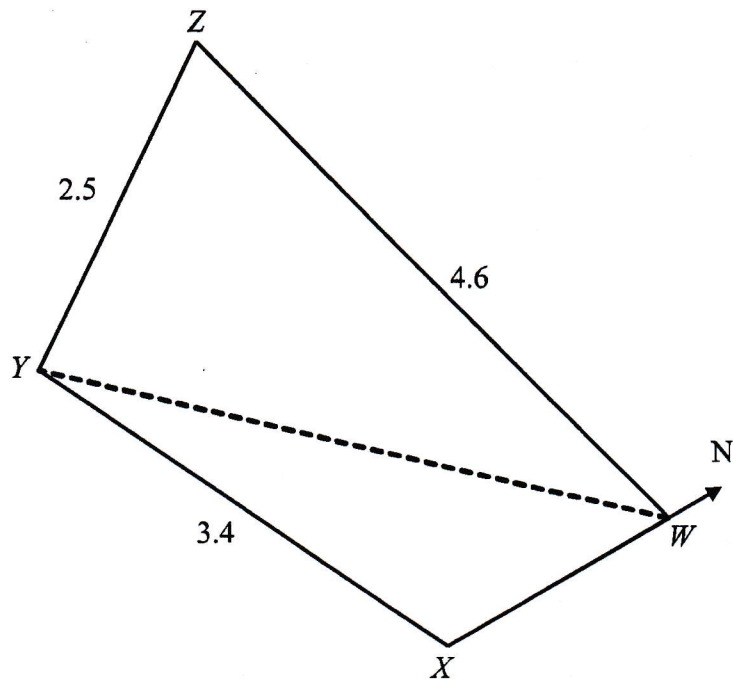

The diagram shows part of a map of a small town.
 Joel's house is located at point W , the childcare centre at point X , the park at point Y and the shopping mall at point Z .

$WZ = 4.6$ km, $YZ = 2.5$ km and $XY = 3.4$ km

The bearing of W from Y is 043.4° and the bearing of X from Y is 064.1° .

- (a) Find the bearing of park Y from childcare centre X .

Answer 244.1° [1]

- (b) Find the distance of park Y from Joel's house W .

Angle $YWX = 43.4^\circ$ (alt. angles, // lines)

$$\frac{3.4}{\sin 43.4^\circ} = \frac{WY}{\sin 115.9^\circ}$$

$$WY = 4.4514 \text{ (to 5 s.f.)}$$

$$= \boxed{4.45 \text{ km}} \text{ (to 3 s.f.)}$$

Answer km [3]

- (c) Find the bearing of the shopping mall Z from Joel's house W .

$$\cos \angle YWZ = \frac{(4.6)^2 + (4.4514)^2 - (2.5)^2}{2(4.6)(4.4514)}$$

$$\angle YWZ = 32.013^\circ \text{ (to 3 d.p.)}$$

Bearing of Z from W

$$= 180^\circ + 43.4^\circ + 32.013^\circ$$

$$= \boxed{255.4^\circ} \text{ (to 1 d.p.)}$$

Answer [3]

- (d) Find the area of the triangle WYZ .

Area of triangle WYZ

$$= \frac{1}{2}(4.6)(4.4514) \sin 32.013^\circ$$

$$= 5.4274$$

$$= \boxed{5.43} \text{ km}^2 \text{ (to 3 s.f.)}$$

Answer km² [2]

- (e) The **smallest** possible angle of depression of a point on the path WY from the top of the shopping mall Z is 25° .

Find the height of shopping mall Z , giving your answer to the nearest metre.

$$\begin{aligned} \text{Height} &= 4.6 \times \tan 25^\circ \\ &= 2.14502 \text{ km} \\ &= 2145.02 \text{ m} \\ &= \boxed{2145} \text{ m (nearest m)} \end{aligned}$$

Answer m [2]

10 (a) Complete the table of values for $y = 10 - \frac{x^2}{2} - \frac{4}{x}$.

| | | | | | | | | |
|-----|-----|-----|-----|---|-----|---|------|------|
| x | 0.5 | 0.7 | 1 | 2 | 3 | 4 | 5 | 6 |
| y | 1.9 | 4.0 | 5.5 | 6 | 4.2 | 1 | -3.3 | -8.7 |

[1]

(b) On the grid opposite, draw the graph of $y = 10 - \frac{x^2}{2} - \frac{4}{x}$ for $0.5 \leq x \leq 6$. [3]

(c) By drawing a tangent, find the gradient of the curve at (2, 6).

Draw tangent correctly at (2, 6)

Gradient of the curve at (2, 6) = -1 (Accepted -0.8 to -1.2)

Answer [2]

(d) By drawing suitable straight lines, find the x -coordinate of the point(s) on the curve at which the gradient of the tangent is 3, in the range $0.5 \leq x \leq 6$.

Drawing of // lines with gradient 3

$x = 1$ (Accepted 0.9 to 1.1)

Answer $x =$ [2]

(e) Use your graph to find the solutions of the equation $x^3 - x^2 - 14x + 8 = 0$ in the range $0.5 \leq x \leq 6$.

$$-\frac{x^2}{2} + \frac{x}{2} + 7 - \frac{4}{x} = 0$$

$$-\frac{x^2}{2} - \frac{4}{x} = -\frac{x}{2} - 7$$

$$10 - \frac{x^2}{2} - \frac{4}{x} = -\frac{x}{2} + 3$$

Draw the line $y = -\frac{x}{2} + 3$ to find the intersections

$x = 0.55$ or $x = 4$ (Accepted ± 0.1)

Answer $x =$ or [3]

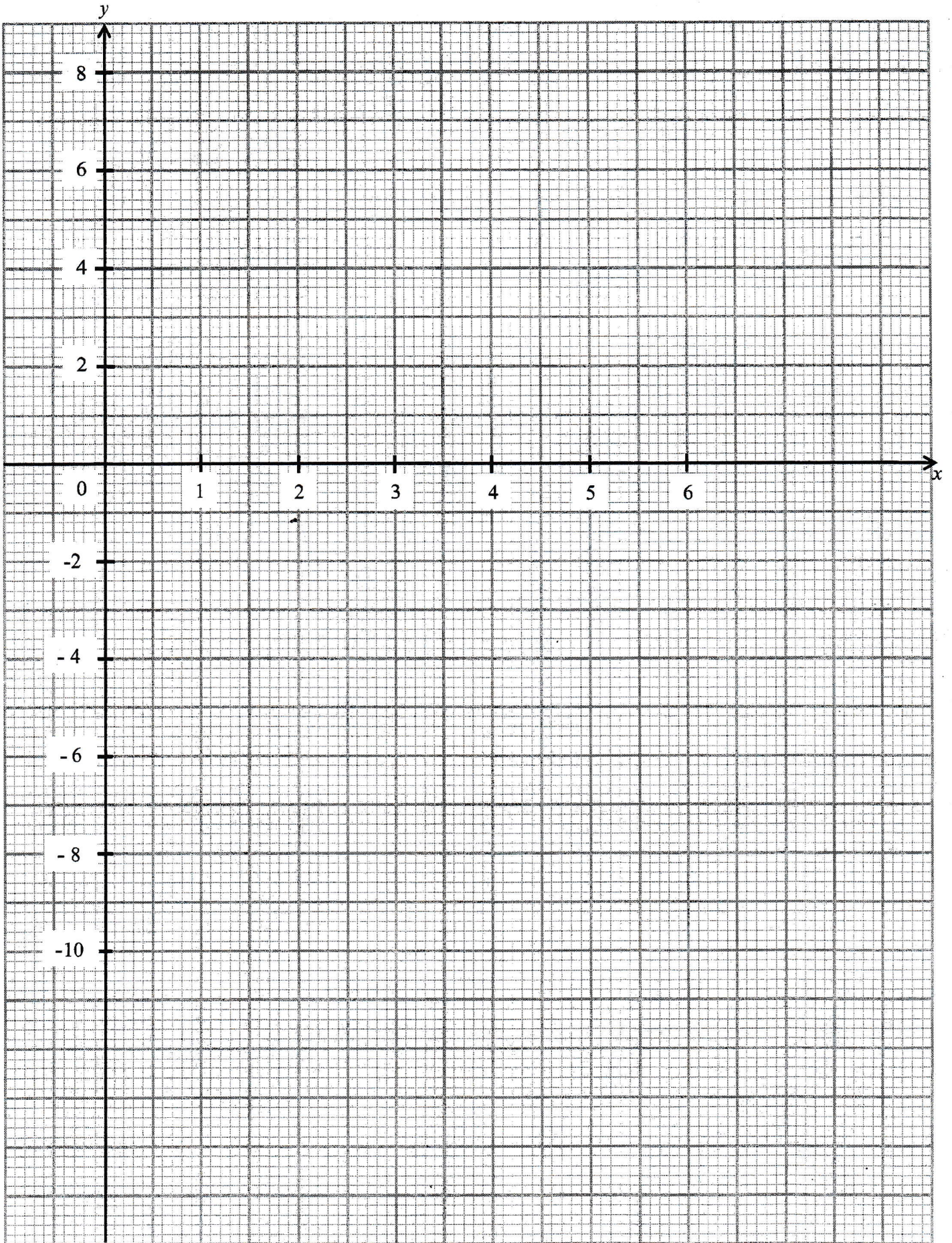

11. Here is some information about a grain storage bin.

Grain Storage Bin

Height (h): 6880 mm

Diameter (d): 4550 mm

Mass: 1100 kg

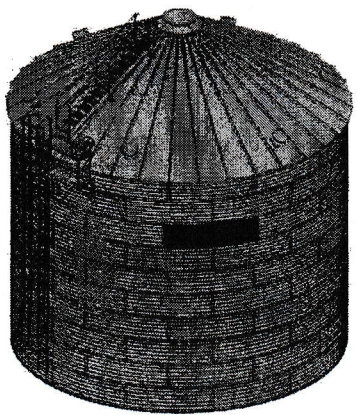

Safety information: The bin can be filled to a maximum of 85% of its total volume.

In this question, the grain storage bin can be modelled as a right cylinder with a right conical top. The height of the conical top is half the radius of the bin.

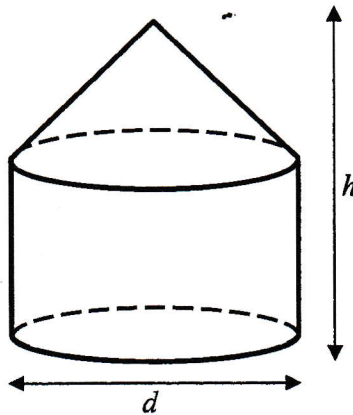

(a) Work out the area, in square metres, of the base of the grain storage bin.

$$\pi \left(\frac{4.550}{2} \right)^2 = 16.260 = \boxed{16.3} \text{ m}^2 \text{ (to 3 s.f.)}$$

Answer m² [1]

(b) Work out the volume, in cubic metres, of the grain storage bin.

$$\left[\frac{1}{3} \pi \left(\frac{4.550}{2} \right)^2 \times \left(\frac{4.550}{4} \right) \right] + \left[\pi \left(\frac{4.550}{2} \right)^2 \times \left(6.880 - \frac{4.550}{4} \right) \right]$$

$$= 99.536 \text{ (to 5 s.f.)}$$

$$= \boxed{99.5} \text{ m}^3 \text{ (to 3 s.f.)}$$

Answer m³ [3]

(c)

| |
|---------------------------|
| Useful information |
|---------------------------|

- | |
|---|
| <ul style="list-style-type: none"> • Density of grain stored: 410 kg/m³ • 1000 kg is equivalent to 9.81 kN |
|---|

The storage bin is never filled to more than its safe volume.
It will need a special load-bearing support structure if its total weight per square metre, on the ground beneath, is greater than 20 kN/m².

Given that the model is an underestimation of the actual storage capacity of the bin, does the bin need a special load-bearing support structure?
Justify your decision with calculations.

Answer

$$\begin{aligned} \text{Safe volume} \\ &= 0.85 \times 99.536 \\ &= 84.606 \text{ m}^3 \end{aligned}$$

$$\begin{aligned} \text{Mass of grains stored} \\ &= 84.606 \times 410 \\ &= 34688 \text{ kg} \end{aligned}$$

$$\begin{aligned} \text{Total load of grains and bin} \\ &= \frac{34688 + 1100}{1000} \times 9.81 \\ &= 351.08 \text{ kN} \end{aligned}$$

$$\begin{aligned} \text{Load per square metre on the ground beneath} \\ &= \frac{351.08}{16.260} \\ &= 21.6 \text{ kN/m}^2 \end{aligned}$$

| |
|--|
| Since $21.6 \text{ kN/m}^2 > 20 \text{ kN/m}^2$ and the model gives an underestimation, so a special load-bearing support structure is needed. |
|--|

.....

.....

.....

[6]

End of Paper

BLANK PAGE